

APM521 多功能仪表
APM521 Multifunctional Instrument

安装使用说明书 V1.0
Installation and Operation Instructions V1.0

安科瑞电气股份有限公司

Acrel Co., Ltd.

申明

Statement

版权所有，未经本公司之书面许可，此手册中任何段落、章节内容均不得摘抄、拷贝或以任何形式复制、传播，否则一切后果由违者自负。

All rights reserved. Without the written permission of the Company, any paragraph or section of this manual shall not be extracted, copied or reproduced or distributed in any form. Otherwise, all consequences shall be borne by the violator.

本公司保留一切法律权利。

The Company reserves all legal rights.

本公司保留对本手册所描述之产品规格进行修改的权利，恕不另行通知。订货前，请垂询当地代理商以获悉本产品的当前规格。

Our Company reserves the right to modify the product specifications described in this manual without further notice. Please consult your local agent for the current specifications of this product before placing an order.

修订记录:

日期	更改前	更改后	内容
2025. 10. 10		V1.0	初始版本

目 录

Contents

1 概述.....	1
1 Overview.....	1
2 型号说明.....	1
2 Description of Model.....	1
3 功能列表.....	2
3 List of Functions.....	2
4 技术参数.....	3
4 Technical Parameters.....	3
5 外形尺寸.....	5
5 Overall Dimensions.....	5
5.1 仪表尺寸（单位：mm 公差：±1mm）.....	6
5.1 Instrument Dimensions（Unit:mm Tolerance: ±1mm）.....	6
6 接线与安装.....	8
6 Connection and Installation.....	8
6.1 安全说明.....	8
6.1 Safety instruction.....	8
6.2 电压电流接线示意图.....	9
6.2 Schematic Diagram of Voltage and Current Connection.....	9
7 主要功能特点.....	13
7 Main functional Features.....	13
7.1 操作说明.....	13
7.1 Operating instructions.....	13
8 操作与显示.....	19
8 Operation and Display.....	19
8.1 显示界面.....	19
8.1 Display Interface.....	19
8.2 编程界面.....	19
8.2 Programming Interface.....	19
8.3 可设置数据项.....	20
8.3 Settable Data Items.....	20
8.3.1 输入设置.....	20
8.3.1 Input.....	20
8.3.2 通信设置.....	24
8.3.2 Com.....	24
8.3.3 报警设置.....	26
8.3.3 Alarm.....	26
8.3.4 开关量设置.....	31
8.3.4 DIDO.....	31
8.3.5 A0 设置.....	34
8.3.5 A0 Settings.....	34
8.3.6 复费率设置.....	36
8.3.6 Multi rate.....	36
8.3.7 需量设置.....	39
8.3.7 Demand.....	39

8.3.8 系统设置.....	41
8.3.8 System Settings.....	41
8.3.9 清除设置.....	44
8.3.9 Clear.....	44
8.3.10 版本信息.....	45
8.3.10 Version information.....	45
8.3.11 相序调整.....	46
8.3.11 Adjustment of Phase Sequence.....	46
9 通信说明.....	48
9 Communication Instructions.....	48
9.1 地址表.....	48
9.1 Address Table.....	48

1 概述

1 Overview

APM521 网络电力仪表（以下简称仪表）按 IEC 国际标准设计，具有全电量测量、电能统计、电能质量分析事件记录功能及网络通讯等功能，主要用于电网供电质量的综合监控。该系列仪表配有功能丰富的 DI/DO 模块、AO 模块，可以灵活实现电气回路全电量测量及开关状态监控。

The APM521 network power meter (hereinafter referred to as the meter) is designed according to IEC international standards, featuring full electrical quantity measurement, energy statistics, power quality analysis, event logging functions, and network communication capabilities. It is primarily used for comprehensive monitoring of power supply quality in power grids. This series of meters is equipped with DI/DO modules and AO modules that offer a wealth of functions, allowing for flexible implementation of full electrical quantity measurement and monitoring of switch statuses in electrical circuits.

2 型号说明

2 Description of Model



图 1 命名规格

Figure 1: Naming specification

注：

1.K:开关量，DI:开关量输入，DO:开关量输出，C:RS485 通讯，M:模拟量输出，CE:以太网通讯，Log:定时记录，R:导轨安装。

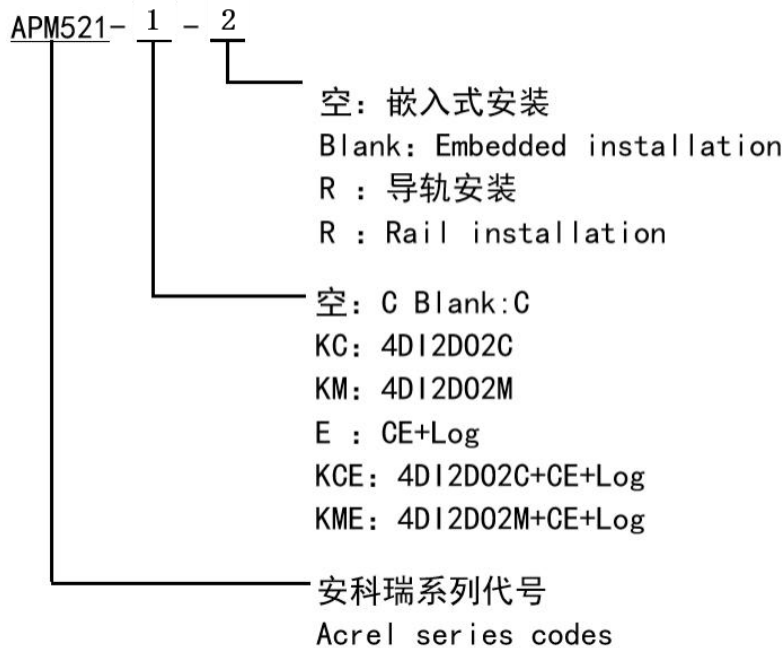
1.Note: K: Digital Input/Output, DI: Digital Input, DO: Digital Output, C: RS485 Communication, M: Analog Output, CE: Ethernet Communication, Log: Timed Recording, R: Rail

Mounting.

2.选配功能模块时，仪表可以同时满足嵌入式安装和导轨安装。R 功能只有在不选配功能模块时，需要导轨安装时才选配。

2.When selecting functional modules, the instrument can support both embedded installation and guide rail installation. The R function is only optional when no functional modules are selected and guide rail installation is required.

3 功能列表

3 List of Functions

表 1 功能说明列表
Table 1 List of Function Descriptions

测量参数 Measured parameters	全电量测量 Total electrical measurement
	四象限电能、四象限无功电能、分相电能、视在电能、复费率电能 Four-quadrant energy、Four - quadrant reactive electric energy、Split phase electricity、Apparent energy、Multi-rate energy
脉冲输出 Pulse output	总有功、总无功电能脉冲输出（无功电能脉冲和时钟脉冲可切换，默认时钟脉冲） Total active power, total reactive power electrical energy pulse output（Reactive energy pulses and clock pulses are switchable, with clock pulses as the default.）
需量 Demand	三相电流、有功功率、无功功率、视在功率实时需量及最大需量(包含时间戳)，上月最大需量(包含时间戳) Three-phase current, active power, reactive power, apparent power real-time demand and maximum demand (including timestamp), last month's maximum demand (including timestamp).
极值统计 Extreme value statistics	电流、线电压、相电压、有功功率、无功功率等电参量本月极值和上月极值(包含时间戳) Current, line voltage, phase voltage, active power, reactive power and other electrical parameters extreme values of this month and last month (including time stamps)
电能质量 Power quality	电流、线电压、相电压不平衡度 Unbalance of current, line voltage, phase voltage
	电压相间角度、电流相间角度 Voltage phase angle, current phase angle
	电压电流总(奇、偶)谐波含量 Total (odd, even) harmonic content of voltage and current
	电压电流分次谐波(2-63 次)含量 Harmonic content of voltage and current (2-63 times)
	电压波峰系数 Voltage peak coefficient
	电压波形因子 Telephone waveform factor

	电流 K 系数 Current K-factor
	矢量图 Vector
	电压、电流实时波形 Voltage and current waveform
	基波电压、基波电流、基波功率因素 Fundamental voltage ,current and power factor
	电压偏差、频率偏差 Voltage deviation, frequency deviation
	正序、负序、零序电压 Positive - sequence voltage, negative - sequence voltage, zero - sequence voltage
	正序、负序、零序电流 Positive - sequence current, negative - sequence current, zero - sequence current
冻结电能 Frozen electric energy	24 时冻结电能、31 日冻结电能、12 月冻结电能、定时冻结电能 24 - hour frozen electric energy, 31 - day frozen electric energy, December frozen electric energy, regular - time frozen electric energy
事件记录 Event logging	DIDO 记录, 可记录最近 128 条 DIDO 记录 DIDO records, which can record the last 128 DID records
报警记录 Alarm logging	可记录最近 128 条报警记录 The last 128 alarm records can be recorded
通讯 Communication	Modbus - RTU 协议、DL/T 645-2007 规约 Modbus - RTU protocol, DL/T 645-2007 statute
选配功能 Optional features	4 路开关量输入, 2 路开关量输出 4-channel digital input and 2-channel digital output
	2 路模拟量输出, 4-20mA 2 channels of analog output, 4-20mA
	扩展第二路 RS485 通讯, Modbus - RTU 协议 Expand the second RS485 communication channel with Modbus - RTU protocol
	扩展以太网通讯, MODBUS-TCP 协议, FTP 协议 Expand Ethernet communication with the MODBUS-TCP protocol, FTP protocol

4 技术参数

4 Technical Parameters

表 2 技术参数说明

Table 2 Description of Technical Parameters

项目 Item		性能参数 Performance Parameters		
Voltage 电压	额定电压 (UL、CE) Rated voltage (UL、CE)	66VAC L-N	115VAC L-L	
		230VAC L-N	400VAC L-L	
		277VAC L-N	480VAC L-L	
		400VAC L-N	690VAC L-L	
	额定电压 (CPA) Rated voltage (CPA)	三相三线 3P3L	三相四线 3P4L	
		3x100V	3x57.7/100V	
		3x380V	3x220/380V	

			3x690V	3x400/690V
		过负荷 Overload	1.2 倍额定值 (连续) 1.2 times rating (continuous) 2 倍额定值持续 1 秒 2 times the rating for 1 second	
		功耗 Power consumption	<1VA	
		精度等级 Accuracy class	误差±0.2% Error ±0.2%	
Current 电流		额定电流 (UL、CE) Rated current (UL、CE)	1A、5A	
		额定电流 (CPA) Rated current (CPA)	0.015-0.075 (6) A (有功电能 Active energy) 3X1(6)A (无功电能 Reactive energy)	
		过负荷 Overload	1.2 倍额定值 (连续) 1.2 times rating (continuous) 10 倍额定值持续 1 秒 10 times the rating for 1 second	
		功耗 Power consumption	<0.2VA	
		精度等级 Accuracy class	误差±0.2% Error ±0.2%	
		功率 Power	有功、无功、视在功率, 误差±0.2% Active, reactive, apparent power, error ±0.2%	
	电网频率 Grid frequency	UL、CE	50Hz/60Hz, 误差±0.2% 50Hz/60Hz, error ±0.2%	
		CPA	50Hz, 误差±0.2% 50Hz, error ±0.2%	
	响应速率 Response rate	≤200ms (电压、电流、功率) ≤200ms (voltage, current, power)		
		≤1s (电能) ≤1s (electrical energy)		
	测量类别 Measurement category	66ULN(+20%) 115ULL(+20%) CATIII 230ULN(+20%) 400ULL(+20%) CATIII 277ULN(+20%) 480ULL(+20%) CATIII 400ULN(+20%) 690ULL(+20%) CAT II		
Metering 计量	电能 Electric energy	有功电能: D 级 (0.2S) Active energy : Class D (0.2S) 无功电能 (准确度等级 2 级) Reactive energy (Class 2 accuracy)		
Auxiliary power supply 辅助电源	AC/DC 85-300V			
	功耗≤4W、10VA power consumption≤4W、10VA			

electromagnetic compatibility 电磁兼容	静电放电抗扰度 IV 级 Electrostatic discharge immunity class IV	
	电快速瞬变脉冲群抗扰度 IV 级 Electrical fast transient burst immunity class IV	
	浪涌(冲击)抗扰度 IV 级 Surge (shock) immunity Class IV	
Security 安全性	工频耐压 Power frequency withstand voltage	通信与信号输入之间 AC4kV 1min Between communication and signal input, AC4kV 1min
	绝缘电阻 Insulation resistance	输入、输出端对机壳>500MΩ Input and output terminals to casing >500MΩ
Communication 通信	接口与通信规约 Interface and communication protocol	RS485 口、Modbus RTU 规约 RS485 interface and Modbus RTU protocol
	通信地址范围 Communication address range	Modbus RTU:1~ 247;
	波特率 Baud rate	支持 1200bps-38400bps Support 1200bps-38400bps
Environment 环境	工作温度 Operating temperature	-40°C~+70°C
	储存温度 Storage temperature	-40°C~+80°C
	相对湿度 Relative humidity	≤95% (无凝露) ≤95% (without condensation)
	海拔高度 Altitude	≤2000m
		≥2000m, ≤5000m (仅用于电源 AC/DC85-265V, 电压 277/480V 以下) ≥2000m, ≤5000m Only applicable to the power supply with the voltage range of AC/DC 85-265V and the voltage below 277/480V.
	安装环境 Installation environment	室内 (干燥) Indoor use (dry location)
	防护等级 IP rating	IP54(前面板), IP30(后壳) IP54(Front panel), IP30(Body)
	污染等级 Pollution degree	Class 2
过电压等级类别 Overvoltage categories	OVC III	
reference standard 参考标准	UL	CAN/CSA C22.2 NO.61010-1-12 UL 61010-1 CSA C22.2 No.61010-2-030 UL 61010-2-030
	IEC、CE	IEC 61010-1 IEC EN 61010-2-30
	CPA	GB/T17215.321-2021 GB/T17215.323-2022

5 外形尺寸

5 Overall Dimensions

5.1 仪表尺寸 (单位: mm 公差: ±1mm)

5.1 Instrument Dimensions (Unit:mm Tolerance: ±1mm)

表 3 尺寸图

Table 3: Dimension Diagram

仪表外形 Meter shape	面框尺寸 Panel size		壳体尺寸 Shell size			开孔尺寸 Cut-out size	
	宽 wide	高 high	宽 wide	高 high	深 deep	宽 wide	高 high
96 方形 96 square shape	96	96	86.5	86.5	50	88	88
选配模块 Optional Module	-	-	86	86	30.5	-	-
导轨式 Rail	-	-	96	96	96	-	-



图 2 APM521 嵌入式安装尺寸图 (无模块)

Figure 2: Installation dimension drawing for embedded installation of APM521 (No module)

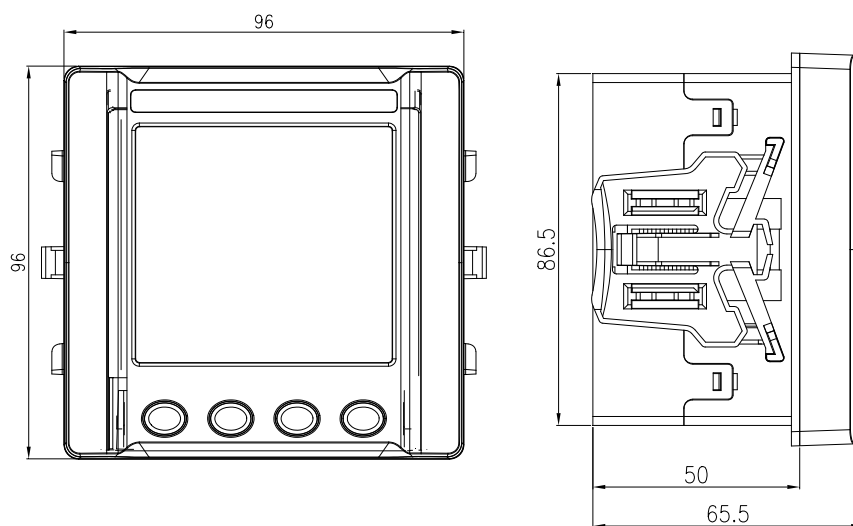

图3 APM521 嵌入式安装尺寸图（有模块）

Figure 2: Installation dimension drawing for embedded installation of APM521 (With module)

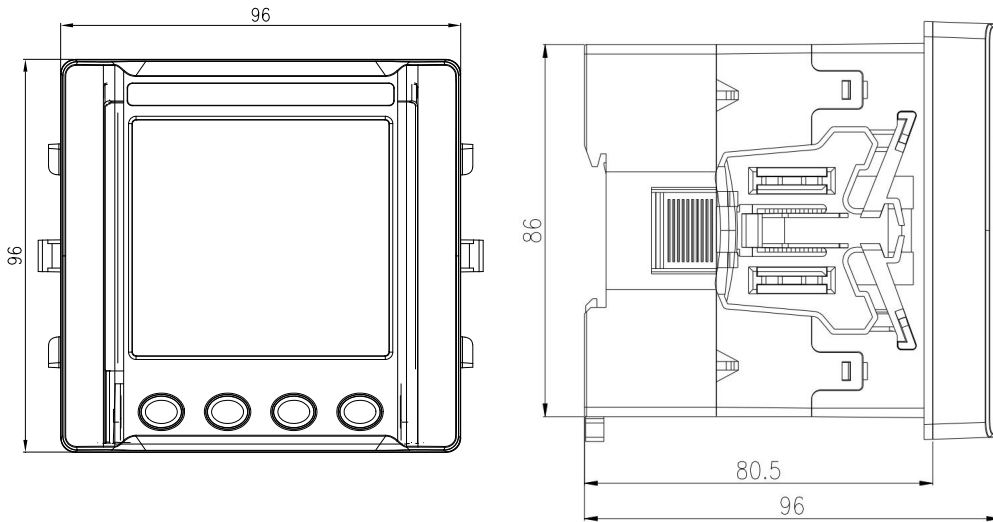

图4 APM521 导轨式安装尺寸图

Figure 4: Installation dimension drawing for rail-mounted installation of APM521

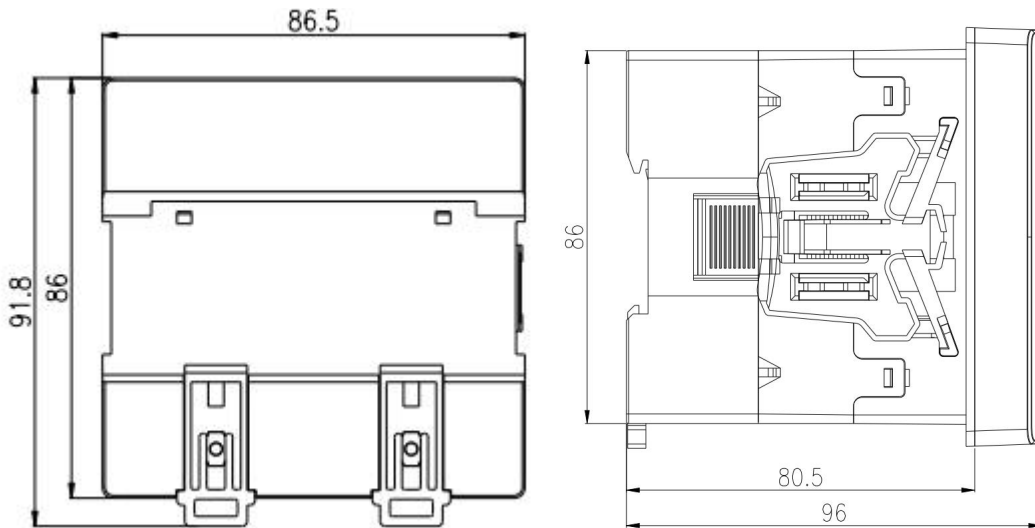

图5 APM521 模块安装尺寸图

Figure5: Installation dimension drawing of APM521 module

注：若统一水平面并排安装仪表，建议仪表开孔间距 30mm。

Note: If the instruments are installed side by side on the same horizontal plane, it is recommended that the spacing between the instrument cutouts be 30mm.

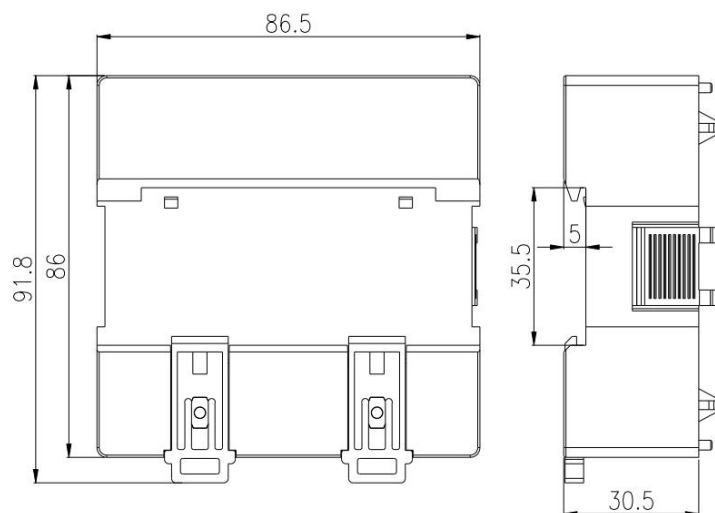
6 接线与安装

6 Connection and Installation

6.1 安全说明

6.1 Safety instruction

为了您的安全着想

Information for your own safety

本说明书不包含设备(模块、设备)运行的所有安全措施，因为特殊的操作条件和当地规范要求或法规可能需要采取进一步的措施。但是，为了您的人身安全和避免损失，它确实包含了必须阅读的信息。根据潜在危险的程序，该信息用警告三角形突出显示，表示如下

This manual does not contain all of the safety measures for operation of the equipment(module, device),because special operating conditions, and local code requirements or regulations may necessitate further measures. However,it does contain information which must be read for your personal safety and to avoid material damages. This information is highlighted by a warning triangle and is represented as follows, depending on the degree of potential danger.

外部变压器与本产品的电流测量回路保持双重或加强绝缘

The external transformer shall maintain double or enhanced insulation with the current measuring loop of this product

Safety Information

The following safety symbols are used in this document. Familiarize yourself with the symbols and their meaning before installing or operating the system.

CAUTION :Risk of Electric Shock, Do Not Remove Cover.No User Serviceable Parts Inside. Refer Servicing To Qualified Service Personnel



PRUDENCE :Le boîtier ne doit en aucun cas être ouvert. Aucun composant interne n'est à entretenir. Reportezvous à un technicien qualifié pour tout entretien.



WARNING :Hazardous voltage is still present 5 minutes after all power sources have been disconnected.

ATTENTION :Une tension dangereuse est toujours présente 5 minutes après que toutes les sources d'alimentation ont été débranchées

INFORMATION provided that when known and used will ensure optimal operation of the system.



La connaissance et l'utilisation des INFORMATIONS fournies garantissent un fonctionnement optimal du système.



在“危险”或“警告”安全标签上加上此符号，表示存在电气危险，如果不遵守指示，可能导致人身伤害。



The addition of this symbol to a “Danger” or “Warning” safety label indicates that an electrical hazard exists which will result in personal injury if the instructions are not followed.



L' apposition de ce symbole sur l' étiquette de sécurité «danger» ou «avertissement» indique la présence d' un danger électrique et le non-respect des instructions entraînera des blessures corporelles.



这是安全警示标志，用于警示潜在的人身伤害危险。请遵守此标志后面的所有安全提示，以避免可能的伤害或死亡。



This is the safety alert symbol. It is used to alert you to potential personal injury hazards. Obey all safety messages that follow this symbol to avoid possible injury or death.



C' est un signe d' avertissement de sécurité. Utilisé pour vous alerter sur les risques potentiels de blessures corporelles. Suivez tous les conseils de sécurité derrière ce signe pour éviter d' éventuelles blessures ou décès.

6.2 电压电流接线示意图

6.2 Schematic Diagram of Voltage and Current Connection



图 6 APM521 典型接线图

Figure 6: Typical Wiring Diagram of APM521

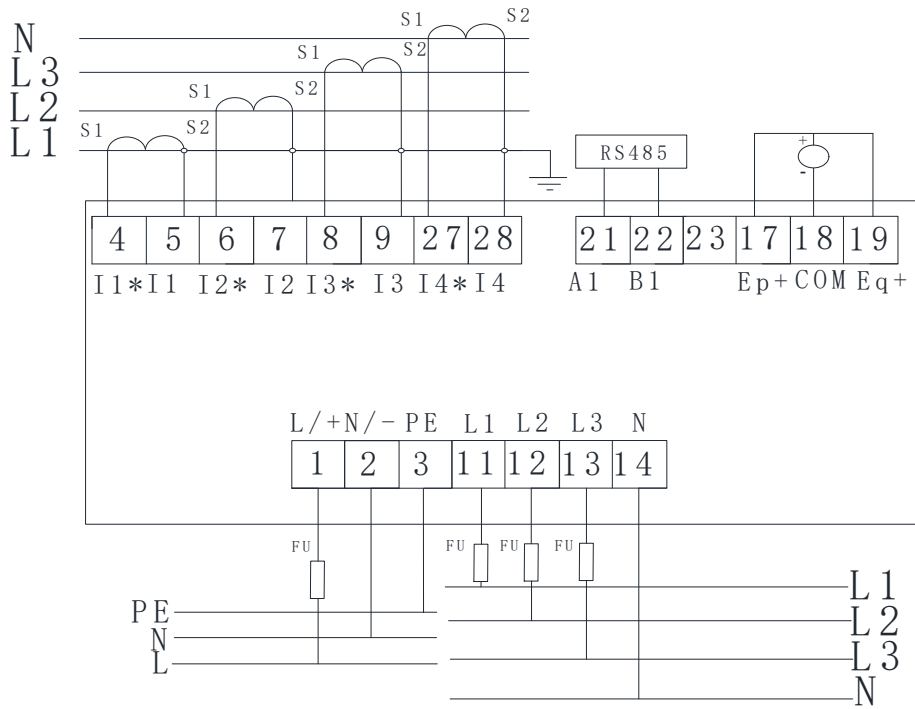

图 7 仪表相线接线示意图

Figure 7: Schematic diagram of the instrument phase line connection

表 4 APM521 端子定义

Table 4 Terminal Definition of APM521

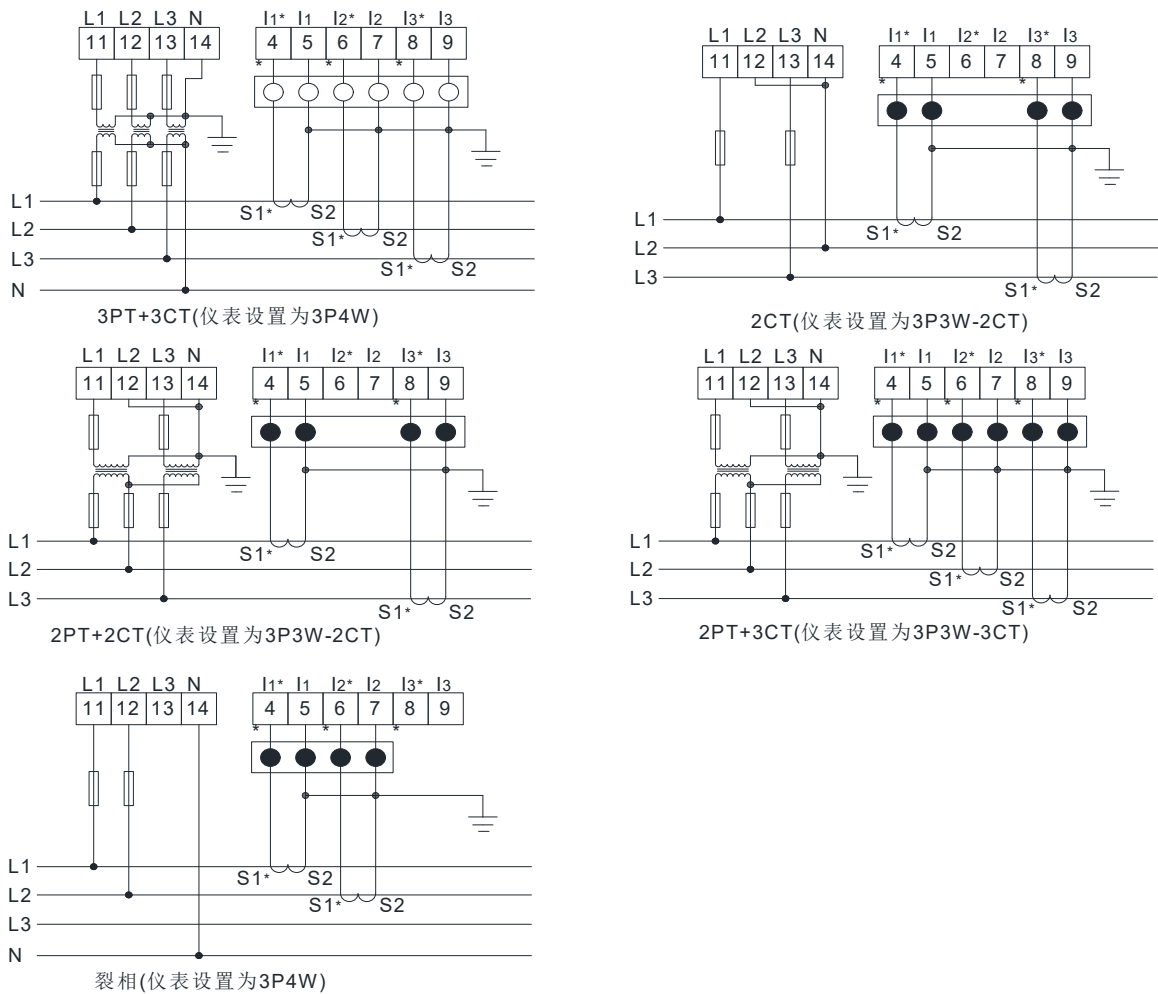
序号 NO	符号 Port	描述 Description	材质 Material
1 2 3	L/+ N/- PE	辅助电源 Auxiliary power supply	CU-AL
4 5 6 7 8 9	I1* I1 I2* I2 I3* I3	电流输入 Current Input	CU-AL
11 12 13 14	L1 L2 L3 N	电压输入 Voltage Input	CU-AL
27 28	I4* I4	中性线电流输入 Neutral Line Current Input	CU-AL
17 18 19	Ep+ COM Eq+	有功脉冲输出、无功脉冲输出 Active Power Pulse Output Reactive Power Pulse Output	CU-AL
21 22	AI B1	RS 485 通讯 RS 485 Communication	CU-AL



图 8 KC(4DI2DO1C)接线图

Figure 8: Wiring Diagram of KC(4DI2DO1C)



图 9 KM(4DI2DO2M)接线图
Figure 9: Wiring Diagram of KM(4DI2DO2M)

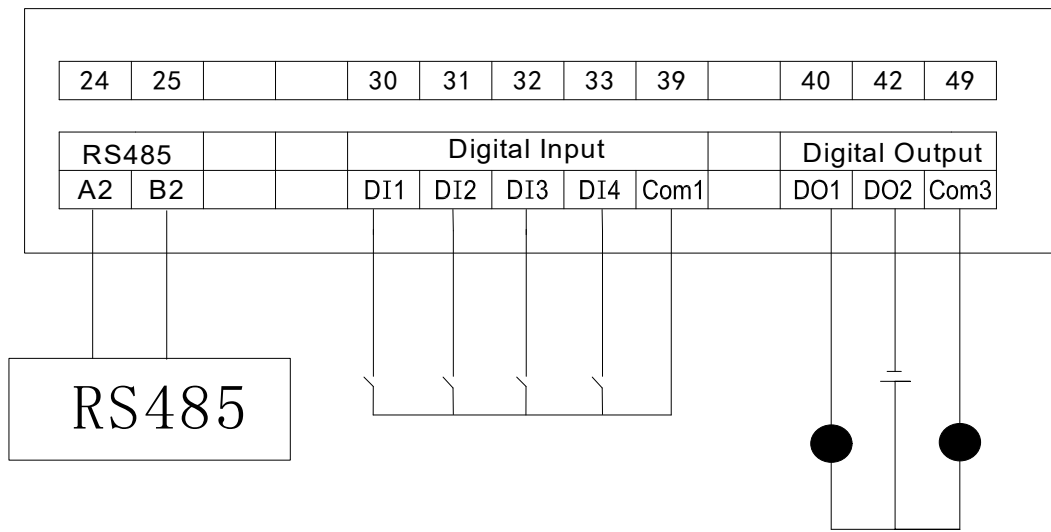

图 10 E(以太网通讯/Log) 接线图
Figure 10: Wiring Diagram of E (Ethernet Communication/Log)

表 5 模块端子定义

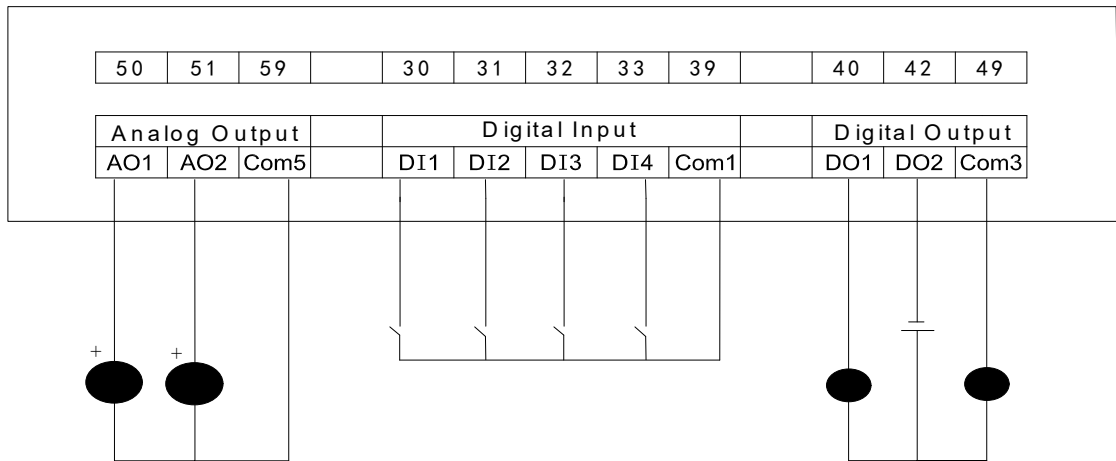
Table 5 Terminal Definition of APM521

序号 NO	符号 Port	描述 Description	材质 Remark
24 25	A2 B2	RS 485 通讯 RS 485 Communication	CU-AL
30 31 32 33 39	DI1 DI2 DI3 DI4 COM1	开关量输入 Digital input	CU-AL
40 42 49	DO1 DO2 COM3	开关量输出 Digital output	CU-AL
50 51 59	AO1 AO2 COM5	模拟量输出 Analog output	CU-AL
-	LAN	以太网通讯 Ethernet communication	
-	Micro SD	定时存储模块 Timing Storage Module	

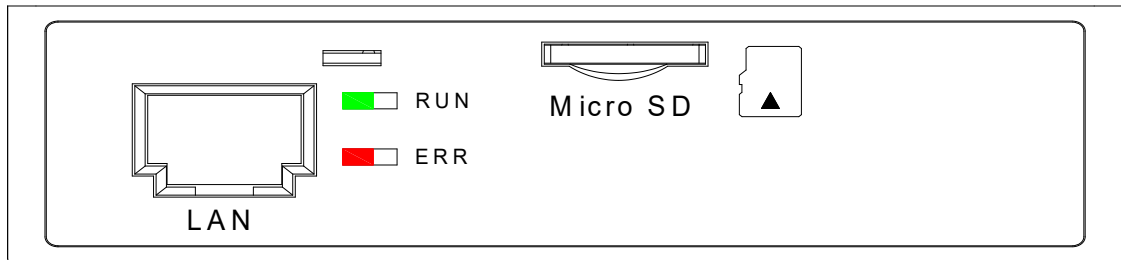
- 推荐线径: 0.08...2.5 mm² (30...14 AWG)
- 所需扭矩为 0.5N•m (4.4 lb-in)
- Recommended cross section: 0.08...2.5 mm² (30...14 AWG)
- The necessary torque is 0.5 N•m (4.4 lb-in).



警告

- 使用额定电压 1000V 的铜线
- 连接到现场接线端子的电缆的最低承受温度为 80° C

不遵守以上说明可能会导致死亡、严重伤害和设备损坏



WARNING

- Use copper wire rated for 1000V.
- Minimum temperature rating of the cable to be connected to the field wiring terminals, 80 °C.

Failure to follow these instructions can result in death, serious injury, or equipment damage.



AVERTISSEMENT

- Utilisez un fil de cuivre évalué pour 1000V.
- Température nominale minimale du câble à connecter aux bornes de câblage sur le terrain, 80 ° C.

Le non-respect de ces instructions peut entraîner la mort, des blessures graves ou des dommages à l' équipement.

注：

1. 出于安全考虑，在电压输入端需接入额定电流 5A 的保险丝和空气开关（断路器）。需要在产品断电后进行接线和维护，互感器端子为强电端子（有触电风险）不可带电触摸）。

1.Note:For safety reasons, a fuse with a rated current of 5A and an Circuit Breaker (switch) must be connected to the voltage input terminal. Wiring and maintenance shall be performed only after the product is powered off. The transformer terminals are high-voltage terminals (with electric shock risk) and must not be touched when energized.

2. 它必须安装在合适的位置，且易于触及。

2. It must be suitably located and easily reached.

3. 它必须标注为该设备的分断装置

3. It must be marked as the disconnecting device for the equipment.

7 主要功能特点

7 Main functional Features

7.1 操作说明

7.1 Operating instructions

7.1.1 导航按键符号说明

7.1.1 Navigation key character number description

表 6 导航按键字符

Table 6 Navigation key character

符号 symbol	说明 description
Menu	按此按钮进入菜单界面 Press this button to enter the menu interface
Esc	按此按键返回至一级菜单 Press this button to return to the first level menu
>	向右，按此按键显示的光标向右移动一个位置或跳转至右一个屏幕 To the right, press the button to display the cursor to move to the right one position or jump to the right one screen
<	向左，按此按键显示的光标向左移动一个位置或跳转至左一个屏幕 To the left, press the button to display the cursor to move one position to the left or to the left screen
^	向上，按此按键将跳转至上一个屏幕或当前菜单界面向上翻页 Up, press this button to jump to the previous screen or the current menu interface to page up
∨	向下，按此按键将跳转至下一个屏幕或当前菜单界面向下翻页 Down, press this button to jump to the next screen or the current menu interface to page down
※	按此按键进入第三级菜单 Press this button to enter the third level menu
√	确认或进入界面 Confirm or enter the interface
◇	按此按键折叠二级菜单 Press this button to collapse the secondary menu
Exit	设置界面退出，连续按 2 次以上则为不保存设置退出 Set the interface to exit, press 2 times or more to exit without saving settings.
Save	保存设置后退出 Exit after saving settings
Enter	确认进入设置 Confirm access to settings
+	数据的递增 Data increment
-	数据的递减 Declining data

7.1.2 菜单显示总览

7.1.2 Menu Overview

表 7 菜单总览

Table 7 Menu Overview

一级菜单 First-level menu	二级菜单 Secondary menu	三级菜单 Three-level menu	备注 Remarks
概览 Overview			线电压平均值、电流平均值、总 P、正向有功电能 EPI Average line voltage, average current, total P, and forward active energy EPI

基本电参量 Basic electrical parameters	电压 Voltage	最大值、最小值 Maximum value, minimum value	线电压、相电压、偏差、角度以及平均值、最大值、最小值。 Line voltage, phase voltage, deviation, Angle, as well as average value, maximum value and minimum value.
	电流 Electric current	最大值、最小值 Maximum value, minimum value	三相电流值、中性线电流、漏电流、偏差、角度、电压电流夹角以及平均值、最大值、最小值。 Three-phase current values, neutral line current, leakage current, deviation, Angle, voltage and current included Angle, as well as average value, maximum value and minimum value.
	频率 Frequency	最大值、最小值 Maximum value, minimum value	频率值以及最大值、最小值。 Frequency values, as well as maximum and minimum values.
	功率 Power	最大值、最小值 Maximum value, minimum value	分相 P、Q、S、PF 和总 P、Q、S、PF 以及最大、最小值。 Classify the phases P, Q, S, PF and the total P, Q, S, PF, as well as the maximum and minimum values.
	温度 Temperature		此菜单为预留菜单，暂未开发。 This menu is a reserved menu and has not been developed yet.
需量 Demand	功率需量 Power demand		当前总 P、Q、S 需量及正向 P、Q、S 最大值与反向 P、Q、S，包含时间戳。 The current total requirements of P, Q, and S, as well as the maximum forward values of P, Q, and S and the reverse values of P, Q, and S, including timestamps.
	电流需量 Current demand		当前每相电流及最大值，包含时间戳。 The current of each phase and the maximum value, including the timestamp.
电能 electric energy	四象限电能 Four-quadrant electrical energy		正向有功电能 EPI、无功电能 EQL、视在电能 ESI；反向有功电能 EPE、无功电能 EQC、净有功电能 EPI-EPE、净无功电能 EQL-EQC、(仪表默认为用电状态，则上述公式成立；若仪表在发电状态，则净有功电能 EPE-EPI、无功电能 EQC-EQL) Forward active energy (EPI), reactive energy (EQL), apparent energy (ESI) Reverse active energy EPE, reactive energy EQC, net active energy EPI-EPE, net reactive energy EQL-EQC, (If the instrument defaults to the power consumption state, the above formulas hold;) If the instrument is in the power generation state, then the net active energy EPE-EPI and reactive energy EQC-EQL
	复费率电能 Multi-rate electricity		正向有功电能 EPI、无功电能 EQL、视在电能 ESI；反向有功电能 EPE、无功电能 EQC、净有功电能 EPI-EPE、净无功电能 EQL-EQC、(仪表默认为用电状态，则上述公式成立；若仪表在发电状态，则净有功电能 EPE-EPI、无功电能 EQC-EQL) Total forward multi-rate electricity (total, sharp, peak, flat, valley, deep valley), total reverse multi-rate electricity (total, sharp, peak, flat, valley, deep valley), total positive multi-rate electricity this month (total, Sharp, peak, flat, valley, deep valley), total reverse multi-rate electric energy (total, sharp, peak, flat, valley, deep valley) and historical 12 month reverse and reverse multi-rate electric energy (total, sharp, peak, flat,

			Valley, deep valley)
	冻结电能 Freeze electrical energy		24 时冻结电能、31 日冻结电能、12 月冻结电能、定时冻结电能 24 - hour frozen electric energy, 31 - day frozen electric energy, December frozen electric energy, regular - time frozen electric energy
电力质量 quality of electric energy	谐波 Harmonic wave	最大值、最小值、总奇偶次谐波 Maximum value, minimum value, total odd and even harmonics	电流总谐波、电流总谐波含量、电压总谐波、电压总谐波含量、电压与电流分次谐波含量、电流总奇次谐波含量、电流总偶次谐波含量、电压总奇次谐波含量、电压总偶次谐波含量、电流谐波含量最大值及最小值以及电压谐波含量最大值及最小值 Total harmonic of current, total harmonic content of current, total harmonic of voltage, total harmonic content of voltage, fractional harmonic content of voltage and current, total odd harmonic content of current, total even harmonic content of current, total odd harmonic content of voltage, total even harmonic content of voltage, maximum and minimum values of current harmonic content, and maximum and minimum values of voltage harmonic content
	因子 Factor		电话波形因子、电压波峰系数、电流 K 系数 Telephone waveform factor, voltage peak coefficient, current K coefficient
	不平衡度 Imbalance		电压/电流不平衡度 Voltage/current imbalance
	矢量 Vector		矢量图、电压序分量(正序、负序、零序)、电流序分量(正序、负序、零序) (选配 S 时, 包含正序、负序分量) Vector diagram, voltage sequence components (positive sequence, negative sequence, zero sequence), current sequence components (positive sequence, negative sequence, zero sequence) (when S is selected, both positive sequence and negative sequence components are included)
	波形 waveform		当前电压波形、当前电流波形, 同相电压电流波形。 Current voltage waveform, current waveform, in-phase voltage and current waveform.
	基波 fundamental wave		基波电压、电流 Fundamental voltage and current
	间谐波 Interharmonic		此菜单为预留菜单, 暂未开发。 This menu is a reserved menu and has not been developed yet.
	闪变 Flicker		此菜单为预留菜单, 暂未开发。 This menu is a reserved menu and has not been developed yet.
	输入输出 Input/Output	开关量输入 Switching inputs	
开关量输出 Switching output			当前开关量输出的状态 The current status of the switch output

	模拟量输入 Analog inputs		此菜单为预留菜单，暂未开发。 This menu is a reserved menu and has not been developed yet。
	模拟量输出 Analog output		当前模拟量输出值 Current analog output value
事件记录 EVENT LOG	DIDO 记录 DIDO recording		DIDO 闭合断开记录，仪表最多存储 128 条 DIDO 事件记录 DIDO closure and disconnection records, the instrument can store up to 128 DIDO event records at most
	报警记录 Alarm recording		当前 Alarm 1、2 状态，仪表最多存储最近报警记录 128 条 In the current Alarm 1 and 2 states, the instrument can store up to 128 recent alarm records at most
	录波记录 Wave recording		此菜单为预留菜单，暂未开发。 This menu is a reserved menu and has not been developed yet。
参数设置 Settings	输入设置 Input setting		相线、一次侧电压、二次侧、一次侧电流、二次侧电流、标称电压、电流，脉冲常数，脉冲输出，电压、电流屏蔽设置 Phase line, primary side voltage, secondary side, primary side current, secondary side current, nominal voltage, current, pulse constant, pulse output, voltage and current shielding Settings
	通信设置 Communications setting		仪表 485 地址、波特率、校验位，仪表 Profibus 地址，645 地址，TCP 端口，IP 地址，子网掩码，默认网关设置 Instrument 485 address, baud rate, check bit, instrument Profibus address, 645 address, TCP port, IP address, subnet mask, default gateway Settings
	无线设置 Wireless settings		此菜单为预留菜单，暂未开发。 This menu is a reserved menu and has not been developed yet。
	报警设置 Alarm settings		报警类型、报警动作值等设置 Settings such as alarm type and alarm action value
	开关量设置 Digital settings		DO 通道、输出选择及延时设置 Digital Output channel, output selection and delay setting
	AI 设置 Analog Input settings		此菜单为预留菜单，暂未开发。 This menu is a reserved menu and has not been developed yet。
	AO 设置 Analog Output settings		AO 通道、类型、小数点及数值设置 AO channel, type, decimal point and value setting
	复费率设置 Multi-Tariff		时区组选择设置、时间段尖峰平谷设置、切换日期设置 Time zone group selection Settings, peak and off-peak time period Settings, and switching date Settings
	录波设置 Recording waves		此菜单为预留菜单，暂未开发。 This menu is a reserved menu and has not been developed yet。
	需量设置 Demand setting		需量滑窗、周期设置 Demand sliding window, cycle setting
	系统设置 System Settings		语言、密码、背光、对比度、极值自清除时间、不平衡算法、时间设置

			Language, password, backlight, contrast, extreme self-clearing time, unbalance algorithm, time setting
	清除 Clear		清除电能、清除需量、清除极值、清除报警及开关量记录、清除暂态波形记录、恢复出厂、复位 Clear electrical energy, clear demand, clear extreme values, clear alarm and switch quantity records, clear transient waveform records, restore to factory, reset
	版本信息 Version		仪表软件版本信息说明 Description of instrument software version information
	相序调整 Adjustment of Phase Sequence		总开关、自动调整、选择方案、电流方向 Main switch、Automatic adjustment、Select a scheme、Current direction

8 操作与显示

8 Operation and Display

8.1 显示界面

8.1 Display Interface

仪表开机显示为仪表型号及版本信息，之后即显示概览界面，仪表默认主界面为概览界面，主界面可设，具体可参考 8.3.8 系统设置之缺省界面设置。

When the instrument is turned on, it displays the model and version information of the instrument. Then, an overview interface is shown. The default main interface of the instrument is the overview interface. The main interface can be set. For specific Settings, please refer to the default interface Settings in 8.3.8 System Settings



图 11 概览界面

Figure 11 Overview interface

8.2 编程界面

8.2 Programming Interface

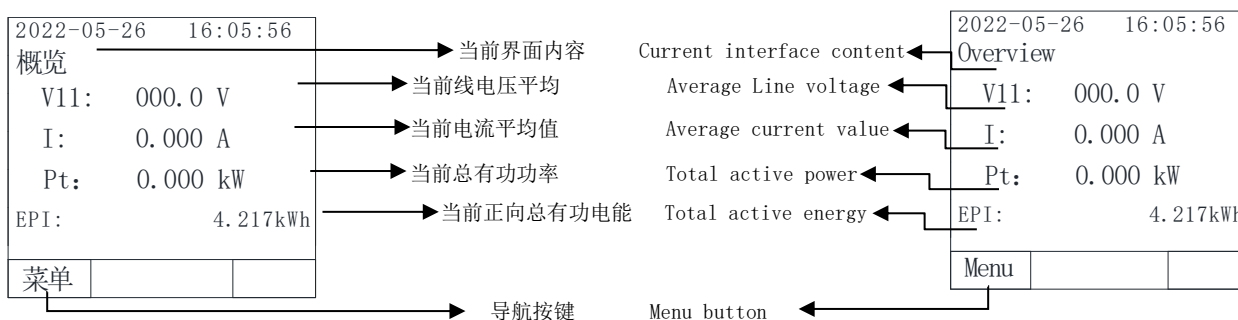
主界面按 Menu 进入菜单编程界面。

Press "Menu" on the main interface to enter the menu programming interface.



图 12 菜单界面

Figure 12 Menu interface

8.3 可设置数据项

8.3 Settable Data Items

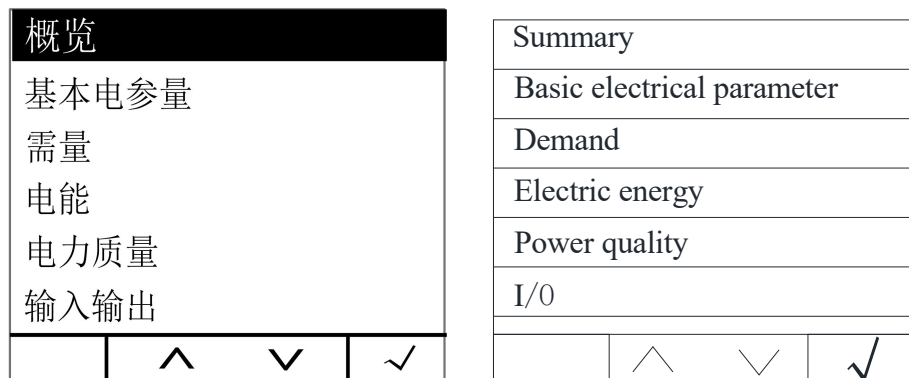
参数设置界面分为以下几个部分：输入设置、通信设置、无线设置、报警设置、开关量设置、AI 设置、AO 设置、复费率设置、录波设置、需量设置、系统设置、清除、版本信息、相序调整。

The parameter setting interface is divided into the following parts: input Settings, communication Settings, Wireless settings, alarm Settings, Digital Settings, AI Settings, AO Settings, multi-rate Settings, recording Settings, demand Settings, system Settings, clearing, and version information, Adjustment of Phase Sequence.



图 13 参数设置界面

Figure 13 Parameter setting interface

8.3.1 输入设置

8.3.1 Input

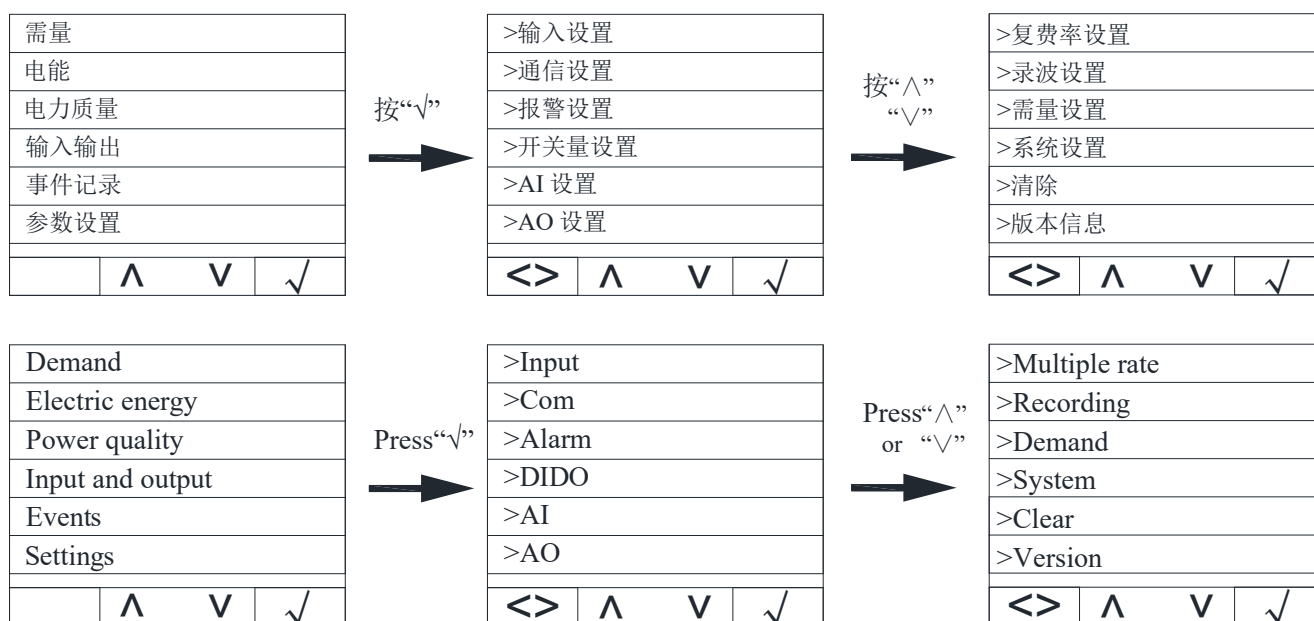
在主界面上，按 Menu 进入菜单界面，按 \vee 直到“参数设置”高亮显示，按 \surd 进入参数设置界面。按 \vee 直到“输入设置”高亮显示，按 \surd 进入输入设置界面。按 \wedge 或 \vee 切换输入设置的项目，按 $>$ 进入该项目的设置，按 $+$ 或 $-$ 进行更改，按 $>$ 进行移位，当前项设置更改完成后，按 Exit 退出该项目设置。继续重复上述操作进行修改设置。更改完成后，按 Exit 弹窗输入密码，默认密码为 0001 (客户可根据 8.3.8 系统设置之密码设置修改密码，如忘记密码，则需联系我司)。按 Save 则保存修改退出，按 Esc 则不保存修改直接退出。

On the main interface, press Menu to enter the menu interface, press \vee until "Settings" is highlighted, and press \surd to enter the parameter Settings interface. Press \vee until "Input" is highlighted, and press \surd to enter the input Settings interface. Press \wedge or \vee to switch the input Settings of the item, press $>$ to enter the Settings of that item, press $+$ or $-$ to make changes, press $>$ to move, after the current item settings are changed, press Exit to exit the item settings. Repeat the above operations to modify the settings. After the modification is completed, press Exit to enter the password input window, the default password is 0001 (customers can modify the password according to the system settings in 8.3.8, if the password is forgotten, please contact our company). Press Save to save the modification and exit, press Esc to exit the modification directly without saving.

press + or - to make changes, press > to shift. After the Settings of the current item are changed, press Exit to exit the Settings of that item. Continue to repeat the above operations to modify the Settings. After the change is completed, press the "Exit" pop-up window to enter the password. The default password is 0001. (Customers can modify the password according to the password Settings set by the 8.3.8 System Settings. If they forget the password, they need to contact our company.) Pressing "Save" will save the modifications and exit, while pressing "Esc" will not save the modifications and exit directly.



图 14 输入设置操作图

Figure 14 Enter the setup operation chart

表 8 输入设置说明

Table 8 Enter setup instructions

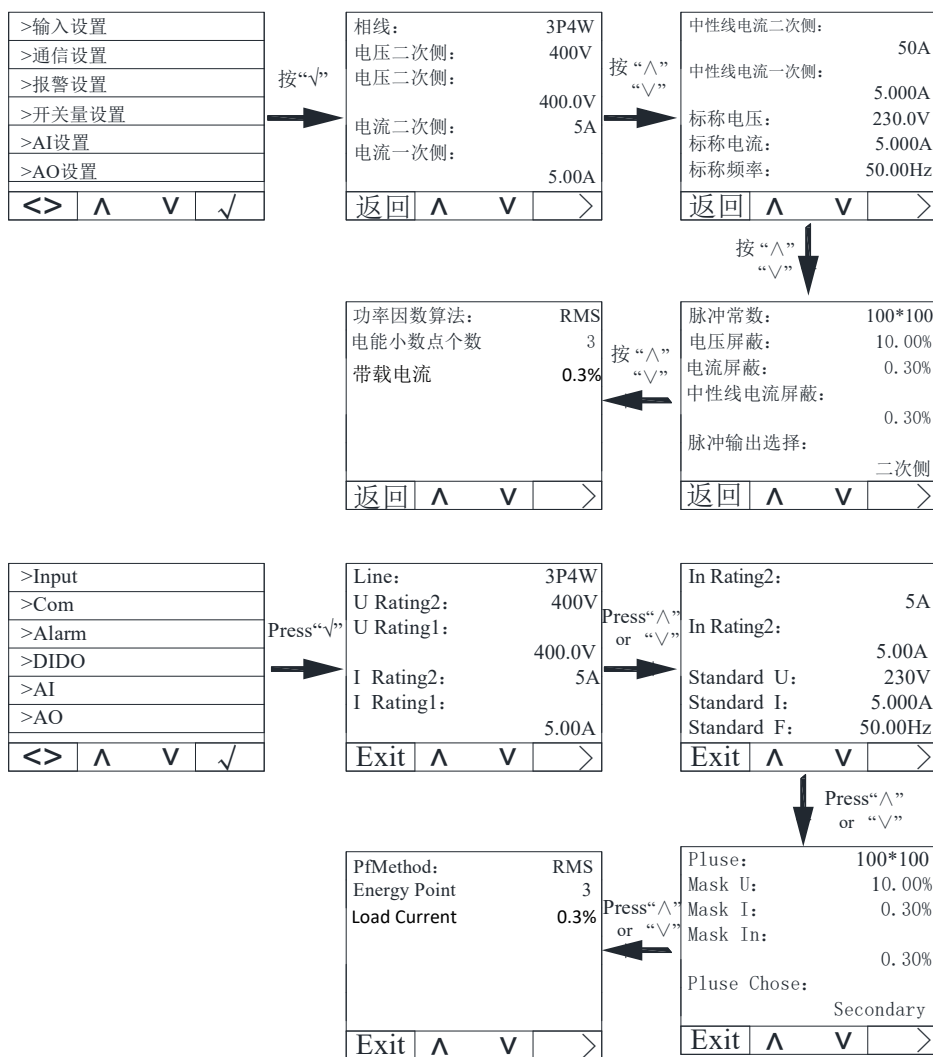
设置项目 project	范围 Scope	说明 Notes	设置依据 Setup basis
相线 Line	3P4W 3P3W-3CT 3P3W-2CT	当前仪表的接线模式 The connection mode of the current meter	设置时必须正确的反应检测点的实际使用的接线方式，错误的接线方式设置将造成装置测量的数据完全是错误的。

			When setting up, it is necessary to correctly reflect the actual wiring method used at the detection points. Incorrect wiring method Settings will cause the measured data of the device to be completely incorrect.
电压二次侧 U Rating2	22-690V	A/B/C 或 AB/BC/CA 三相二次侧电压额定值, 此参数影响装置的测量结果显示。 A/B/C or AB/BC/CA three-phase secondary side voltage rating, this parameter affects the measurement results of the device display.	依据现场测试需要进行输入设置, 仪表显示测量结果均为一次测值。 Input Settings are carried out according to the needs of field test, and the measurement results displayed by the instrument are all measured values at one time.
电压一次侧 U Rating1	50~1999999 V	A/B/C 或 AB/BC/CA 三相一次侧电压额定值, 此参数影响装置的测量结果显示。 A/B/C or AB/BC/CA three-phase primary side voltage rating, this parameter affects the measurement results of the device display.	
电流二次侧 I Rating2	1A、5A	A/B/C 三相二次侧电流额定值, 此参数影响装置的测量结果显示。 A/B/C three-phase secondary side current rating, this parameter affects the measurement results of the device display.	
电流一次侧 I Rating1	1~59999A	A/B/C 三相一次侧电流额定值, 此参数影响装置的测量结果显示。 A/B/C three-phase primary side current rating, this parameter affects the measurement results of the N-phase secondary side current rating, this parameter affects the measurement results of the device display.device display	

中性线电流二次侧 In Rating2	1A、5A	N 相二次侧电流额定值，此参数影响装置的测量结果显示。 N-phase secondary side current rating, this parameter affects the measurement results of the device display.	
中性线电流一次侧 In Rating1	1~59999A	N 相一次侧电流额定值，此参数影响装置的测量结果显示。 N-phase primary side current rating, this parameter affects the measurement results of the device display.	
标称电压 Standard U	10~999.9V	理论上的电压值，影响暂态事件判断中电压上下越限的判断（3P3W 时标称电压为线电压） The theoretical voltage value, which affects the judgment of the voltage upper and lower limit in the judgment of transient events (the nominal voltage at 3P3W is the line voltage)	依据现场实际情况设置为二次侧值相电压值，市电通常设置为 230V。 According to the actual situation of the field, it is set to the secondary side value phase voltage value, and the mains power is usually set to 230V.
标称电流 Standard I	0.1~9.999A	理论上大部分情况下的电流值，影响暂态事件冲击电流判断 Theoretically, the current value in most cases affects the judgment of transient event impact current	依据现场实际情况设置为二次侧值相电流值。 According to the actual situation of the field, it is set to the secondary side value phase current value.
标称频率 Standard F	45.00-65.00 Hz	用于计算频率偏差 It is used to calculate the frequency deviation	依据现场实际情况设置 Set according to the actual situation of the site
脉冲常数 Pulse	100~99900	每 kWh（kvar、kVA）小时脉冲的个数 Number of pulses per kWh (kvar, kVA) hour	根据用户需求设置，默认值 10000。 Set according to user requirements, the default value is 10000.
电压屏蔽 Mask U	0~99.99%	电压测量屏蔽值 Voltage measurement screen value	根据用户需求设置，默认值 10%。 According to user requirements, the

			default value is 10%.
电流屏蔽 Mask I	0~9.99%	电流测量屏蔽值 Current measurement screen value	根据用户需求设置，默认值 0.30%。 Set according to user requirements, the default value is 0.30%.
中心线电流屏蔽 Mask In	0~9.99%	中心线电流测量屏蔽值 Center line current measurement screen value	根据用户需求设置，默认值 0.30%。 Set according to user requirements, the default value is 0.30%.
脉冲输出选择 Pluse Chose	一次侧、 二次侧 Primary、 Secondary	有功电能脉冲，无功电能脉冲对应关系 The corresponding relationship between the active electrical energy pulse and the reactive electrical energy pulse	
功率因素算法 PfMethod	PQS、RMS	PF=P/S PQS:S= $\sqrt{(P^2 + Q^2)}$ RMS:S=UI	根据用户需求设置，默认值 RMS。 Set according to user requirements, the default value is RMS.
电能小数点个数 Number of decimal places for electrical energy	3/4	电能显示小数位数 Decimal places for electricity energy display	根据用户需求设置，默认值 3。 Set according to user requirements, the default value is 3.
带载电流 Load current	0~9.99%	区分带载时间和空载时间的电流 Distinguishing the current between loaded time and no-load time	根据用户需求设置，默认值 0.30%。 Set according to user requirements, the default value is 0.30%.

8.3.2 通信设置

8.3.2 Com

在主界面上，按 **Menu** 进入菜单界面，按 **∨** 直到“参数设置”高亮显示，按 **√** 进入参数设置界面。按 **∨** 直到“通信设置”高亮显示，按 **√** 进入通信设置界面。按 **∧** 或 **∨** 切换通信设置的项目，按 **Enter** 进入该项目的设置，按 **+** 或 **-** 进行更改，按 **>** 进行移位，当前项设置更改完成后，按 **Exit** 退出该项目设置。继续重复上述操作进行修改设置。更改完成后，按 **Exit** 弹窗输入密码，默认密码为 0001(客户可根据 8.3.8 系统设置之密码设置修改密码，如忘记密码，则需联系我司)。按 **Save** 则保存修改退出，按 **Esc** 则不保存修改直接退出。

On the main interface, press Menu to enter the menu interface, press \checkmark until "Settings" is highlighted, and press \checkmark to enter the parameter setting interface. Press \checkmark until "Com" is highlighted, and press \checkmark to enter the communication Settings interface. Press \wedge or \vee to switch the item of communication setting, press Enter to enter the setting of this item, press + or - to change, press > to shift, and press Exit to exit the item setting after the change of the current item setting is completed. Go ahead and repeat to change the Settings. After the change is completed, press the Exit pop-up window to enter the password. The default password is 0001(Customers can change the password according to the password Settings set in 8.3.8 system. If they forget the password, they need to contact our company). Press Save to exit with the changes saved, and press Esc to exit without saving the changes.



图 15 通讯设置界面

Figure 15 Communication setup interface

表 9 通讯设置说明

Table 9 Communication Settings Description

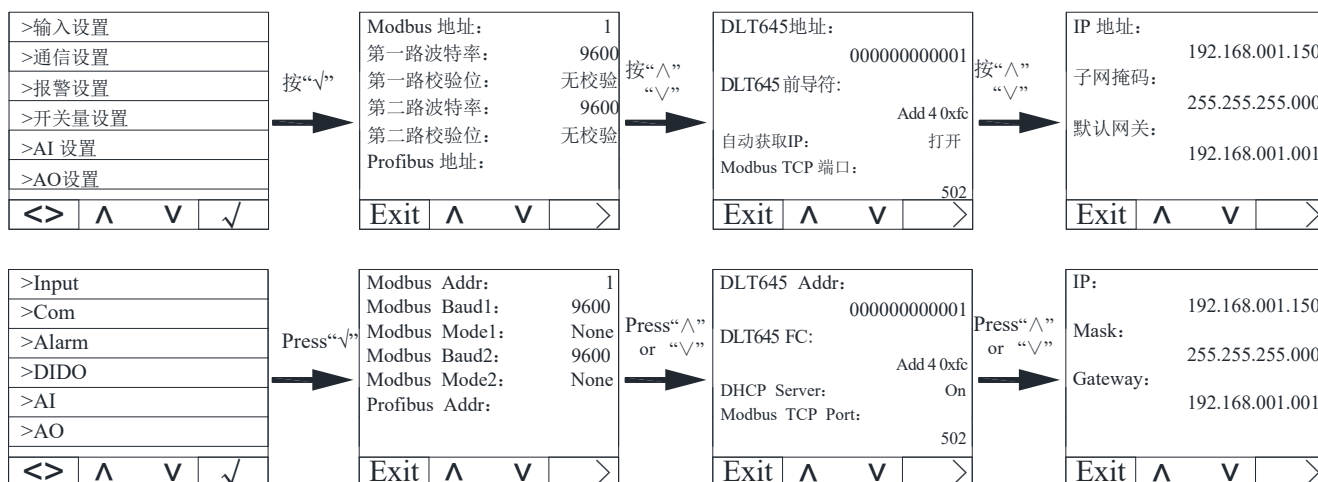
设置项目 project	范围 Scope
Modbus 地址 Modbus Addr	1~247
第 1 路波特率 Modbus Baud1	1200, 2400, 4800, 9600, 19200, 38400
第 1 路校验位 Modbus Mode1	无校验、2 位停止位、奇校验、偶校验 None , 2Stop bit, Odd, Even
第 2 路波特率 Modbus Baud2	1200, 2400, 4800, 9600, 19200, 38400
第 2 路校验位	无校验、2 位停止位、奇校验、偶校验

Modbus Mode2	None, 2stop bit, Odd, Even
Profibus 地址 Profibus Addr	1~126
DLT645 地址 DLT645 Addr	0~999999999999
DLT645 前导符 DLT645 FC	Add None(无前导符)
Modbus TCP 端口 Modbus TCP Port	1~59999
IP 地址 IP	默认 192.168.1.150 The default value is 192.168.8.150
子网掩码 Mask	默认 255.255.255.0 The default value is 255.255.255.0
默认网关 Gateway	默认 192.168.1.1 The default value is 192.168.1.1

8.3.3 报警设置

8.3.3 Alarm

在主界面上，按 **Menu** 进入菜单界面，按 **∨** 直到“参数设置”高亮显示，按 **√** 进入参数设置界面。按 **∨** 直到“报警设置”高亮显示，按 **√** 进入报警设置界面。按 **∧** 或 **∨** 切换报警设置的项目，按 **>** 进入该项目的设置，按 **+** 或 **-** 进行更改，按 **>** 进行移位，当前项设置更改完成后，按 **Exit** 退出该项目设置。继续重复上述操作进行修改设置。更改完成后，按 **Exit** 弹窗输入密码，默认密码为 0001(客户可根据 8.3.8 系统设置之密码设置修改密码，如忘记密码，则需联系我司)。按 **Save** 则保存修改退出，按 **Esc** 则不保存修改直接退出。

On the main interface, press **Menu** to enter the menu interface, press **∨** until "Settings" is highlighted, and press **√** to enter the parameter setting interface. Press **∨** until "Alarm" is highlighted, and press **√** to enter the alarm setting interface. Press **∧** or **∨** to switch the item of alarm setting, press **>** to enter the item's setting, press **+** or **-** to change, press **>** to shift, and press **Exit** to exit the item setting after the change of the current item setting is completed. Go ahead and repeat to change the Settings. After the change is completed, press the **Exit** pop-up window to enter the password. The default password is 0001(Customers can change the password according to the password Settings set in 8.3.8 system. If they forget the password, they need to contact our company). Press **Save** to exit with the changes saved, and press **Esc** to exit without saving the changes.

报警类型参考 9.1 查看报警表 1：报警分类说明

For alarm types, refer to 9.1. Check Alarm Table 1: Alarm Classification Description



图 16 报警设置界面

Figure 16 Alarm setting interface

表 10 报警设置说明

Table 10 Alarm setting Instructions

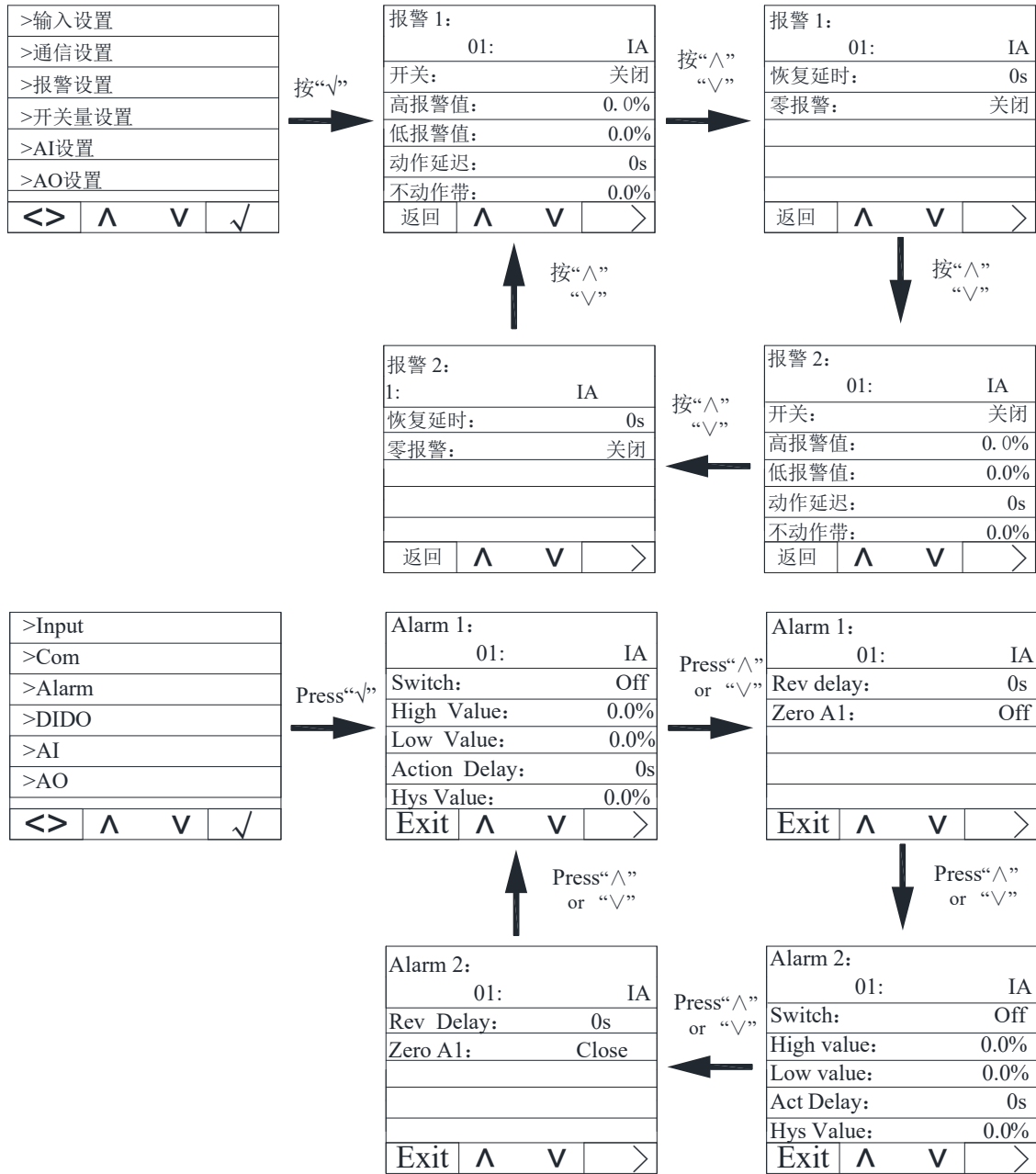
设置项目 project	范围 scope	说明 description
报警 1 各类型 Alarm 1		参考 9.1 查看报警表 1：报警分类说明 Refer to 9.1 for alert Table 1: Alert classification description
报警开关	打开、关闭	Turn on or off the alarm

Switch	on 、 off	
高报警值 High Value	0~999.9%	报警动作值，单位和小数点位置与仪表显示值保持一致 Alarm action value, unit and decimal position are consistent with the meter display value
低报警值 Low Value	0~999.9%	报警动作值，单位和小数点位置与仪表显示值保持一致 Alarm action value, unit and decimal position are consistent with the meter display value
动作延时 Action Delay	0~9999	报警延时值，单位：秒 Alarm delay value in seconds
复归阈值 Hys Value	-9999~9999	报警恢复值，单位和小数点位置与仪表显示值保持一致 Alarm action value, unit and decimal position are consistent with the meter display value
复归延时 Rev Delay	0~9999	报警恢复延时值，精确到秒 Alarm recovery delay value, accurate to seconds
零报警开关 Zero Al	打开、关闭 on 、 off	零值报警使能，低报警时有效 Zero alarm enabled, effective at low alarm

报警说明：

仪表带两组报警，每组报警可以检测多种报警条件，包括电参量开关量输入变化、相损、逆相序、不平衡度、谐波等。其中开关量输入变化和逆相序只需设置使能位，其余报警需要设定报警条件。

Alarm Description:

Instrument with two sets of alarm, each set of alarm can detect a variety of alarm conditions, including electrical parameters switching input changes, phase loss, reverse phase sequence, imbalance, harmonics and so on. The switch input change and reverse phase sequence only need to set the enable bit, and the other alarm needs to set the alarm condition.

报警类型简介：

Introduction to Alarm Types:

1. 电参量报警

1. Electrical Parameter Alarms

过流：零值报警设置不适用于过流报警，当单相电流高于或等于动作值且满足设定的动作延时时间，启动单相过流报警；当单相电流低于设定的恢复值且满足延时时间，单相过流报警解除。

Overcurrent: Zero-value alarm setting is not applicable to overcurrent alarms. When the current of a single phase is

higher than or equal to the action value and meets the set action delay time, a single-phase overcurrent alarm is triggered; when the current of a single phase is lower than the set recovery value and meets the delay time, the single-phase overcurrent alarm is cleared.

欠流：当单相电流低于或等于动作值且满足设定的动作延时时间，启动单相过流报警；当单相电流高于设定的恢复值且满足延时时间，单相过流报警解除。

Undercurrent: When the current of a single phase is lower than or equal to the action value and meets the set action delay time, a single-phase undercurrent alarm is triggered; when the current of a single phase is higher than the set recovery value and meets the delay time, the single-phase undercurrent alarm is cleared.

注：当欠流使能且零值报警使能时，此时单相电流等于 0 时，报警有效；当欠流使能且零值报警禁止时，此时单相电流等于 0 时，报警无效。

When undercurrent enable and zero value alarm enable, the alarm is valid when the single-phase current equals 0; when undercurrent enable and zero value alarm disable, the alarm is invalid when the single-phase current equals 0.

2. 相损电流报警

2. Alarm for mutual damage current

当任一电流(非所有电流)等于或低于动作值且满足延时时间时，产生相损电流报警；而当以下任一情况出现时，报警解除：

When any current (not all currents) is equal to or lower than the operating value and the delay time is met, a phase loss current alarm is generated; and the alarm is cleared when any of the following situations occurs:

三相电流均高于恢复值且满足延时时间

The three-phase currents are all higher than the recovery value and meet the delay time requirement.

三相电流均低于相损动作值

The three-phase currents are all below the phase loss action value.

3. 逆相序报警：动作和恢复值及延时值不适用于逆相序报警，当相序不是 ABC 正常相序，产生逆相序报警。

3. Reverse phase sequence alarm: The action and recovery values as well as the delay value are not applicable to the reverse phase sequence alarm. When the phase sequence is not the normal ABC sequence, a reverse phase sequence alarm will be triggered.

4. DI 报警：当 DI 状态由初始状态改变时，产生报警。

4. DI Alarm: An alarm is triggered when the DI status changes from its initial state.

以下为仪表如何处理报警参数示意图。

The following is a diagram illustrating how the instrument handles alarm parameters.



图 17 报警参数示意图

Figure 17 Diagram of alarm parameters

举例如下：

Here are some examples:

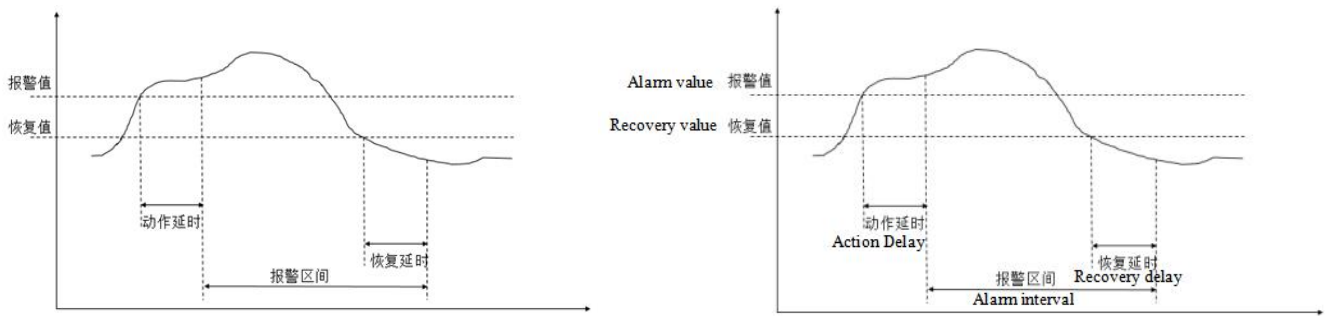
设定第一组报警 A 相电流过流报警使能。

Set the first group of alarm: Enable the A-phase current overcurrent alarm.

动作值：该动作值为一次侧值，如：设定报警值为 5.500A，则当 A 相电流值超过 5.500A 时，报警条件触发，开始计时。

Action value: This action value is the primary side value. For example, if the alarm value is set to 5.500A, then when the A-phase current value exceeds 5.500A, the alarm condition is triggered and the timing begins.

动作延时：当报警条件触发后，如果 A 相电流值一直超过 5.500A，则在延时设定值(精确到秒)后产生报警记录，记录报警组别(Alarm1)，报警类型(A 相过流)，报警时间(如：2019-2-12 14:15:20)，若 DO 关联了该报警，则 DO 动作(详见 DO 设置)。

Action delay: After the alarm condition is triggered, if the A-phase current value remains above 5.500A, an alarm record will be generated after the delay set value (accurate to seconds). The record will include the alarm group (Alarm1), alarm type (A-phase overcurrent), and alarm time (e.g., 2019-2-12 14:15:20). If the DO is associated with this alarm, then the DO action (refer to DO settings) will occur.

恢复值：该恢复值为一次侧值，如：设定恢复值为 5.400A，在已经发生 A 相过流报警后，则当 A 相电流值低于 5.400A 时，解除报警条件触发，开始计时。

Restore value: This restore value is the primary side value. For example, if the restore value is set to 5.400A, after an A-phase overcurrent alarm has occurred, then when the A-phase current value is lower than 5.400A, the alarm condition is triggered and the timing begins.

恢复延时：当解除报警条件触发后，如果 A 相电流值一直低于 5.400A，则在延时设定值(精确到秒)后产生解除报警记录，记录报警组别(Alarm1)，报警类型(A 相过流)，解除报警时间(如：2019-2-12 14:17:20)，若 DO 关联了该报警，则 DO 恢复原状态。由此可计算出报警时长为 2 分钟。

Restore delay: After the alarm condition is triggered to be released, if the A-phase current value remains below

5.400A, an alarm release record will be generated after the delay set value (accurate to seconds). The record will include the alarm group (Alarm1), alarm type (A-phase overcurrent), and alarm release time (e.g., 2019-2-12 14:17:20). If the DO is associated with this alarm, then the DO will restore to its original state. Thus, the alarm duration can be calculated as 2 minutes.

注：动作值和恢复值均为零时报警无效。

Note: The alarm will be ineffective when both the action value and the recovery value are zero.

注：对于高报警类型，恢复值需小于报警值，对于低报警类型，恢复值需大于报警值。

Note: For high alarm types, the recovery value must be less than the alarm value; for low alarm types, the recovery value must be greater than the alarm value.

8.3.4 开关量设置

8.3.4 DIDO

在主界面上，按 Menu 进入菜单界面，按 √ 直到“参数设置”高亮显示，按 √ 进入参数设置界面。按 √ 直到“DO 设置”高亮显示，按 √ 进入 DIDO 设置界面。按 ^ 或 √ 切换 DIDO 设置的项目，按 Enter 进入该项目的设置，按 + 或 - 进行更改，按 > 进行移位，当前项设置更改完成后，按 Exit 退出该项目设置。继续重复上述操作进行修改设置。更改完成后，按 Exit 弹窗输入密码，默认密码为 0001 (客户可根据 8.3.8 系统设置之密码设置修改密码，如忘记密码，则需联系我司)。按 Save 则保存修改退出，按 Esc 则不保存修改直接退出。

On the main interface, press "Menu" to enter the menu interface. Press "√" until "Settings" is highlighted, then press "√" to enter the parameter settings interface. Press "√" until "DIDO" is highlighted, then press "√" to enter the DIDO settings interface. Press "^" or "√" to switch between the items of the DIDO settings, press "Enter" to enter the settings of the current item, press "+" or "-" to make changes, press ">" to shift, and after the current item settings are changed, press "Exit" to exit the settings. Repeat the above operations to modify the settings. After the settings are changed, press "Exit" to pop up a window and enter the password. The default password is 0001 (customers can modify the password according to the password settings in the 8.3.8 system. If the password is forgotten, please contact our company). Press "Save" to save the modifications and exit, or press "Esc" to not save the modifications and exit directly.



图 18 开关量设置界面
Figure 18 Switch quantity setting interface



此处需勾选 DO 关联的报警类型，具体报警类型，请参照 5.1.2 的表 1 即报警产生时 DO 动作；若不勾选，则为不关联，即报警产生时 DO 不动作。

Here you need to check the DO associated alarm type, the specific alarm type, please refer to Table 1 of 5.1.2, that is, the DO action when the alarm is generated; If it is not checked, it is not associated, that is, the DO does not move when the alarm is generated.

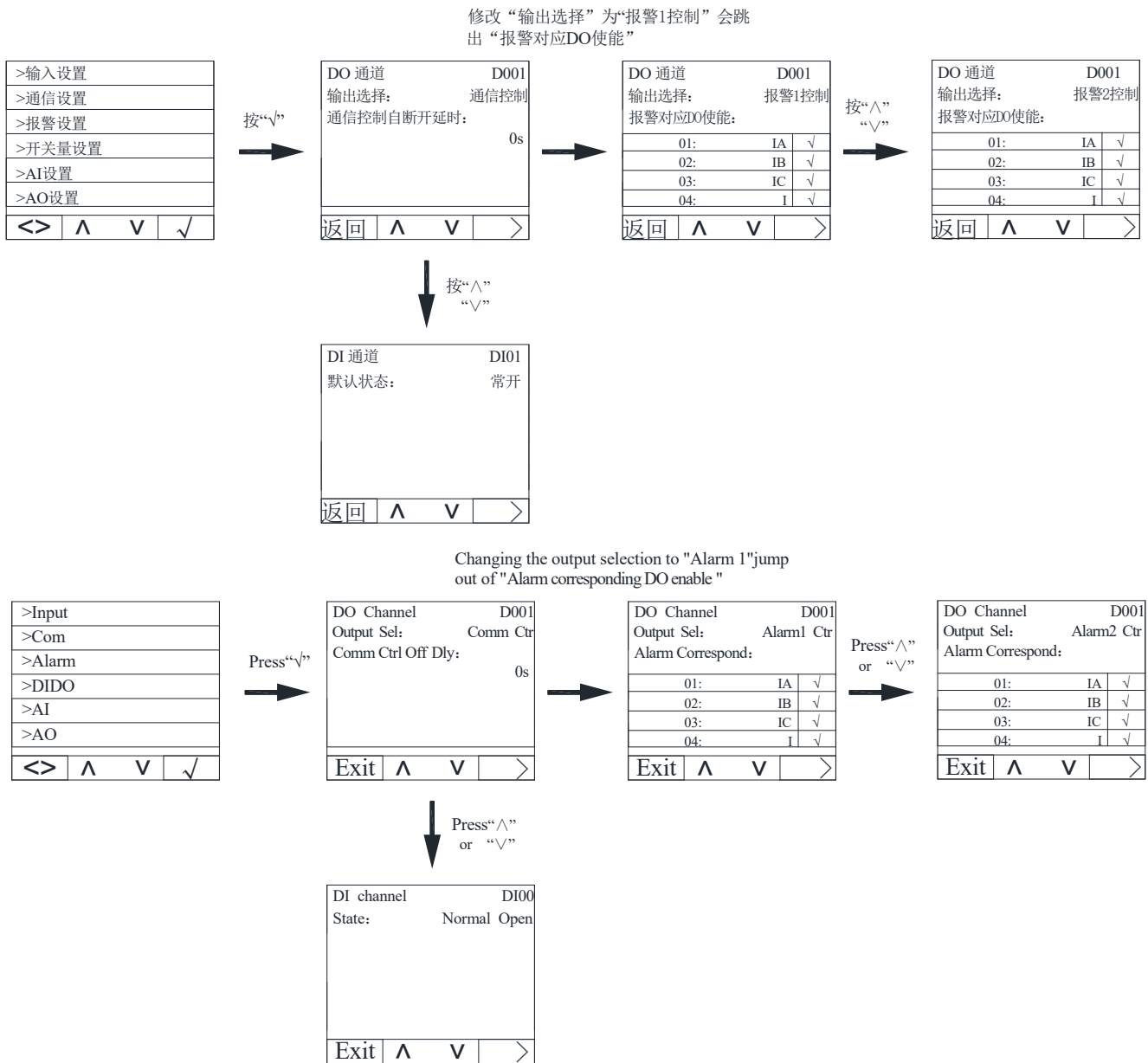
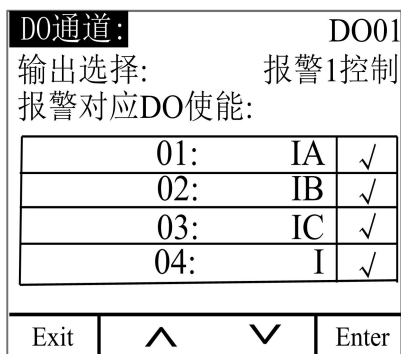
图 19 关联报警控制
Figure 19 Correlated alarm control

表 11 开关量设置说明

Table 11 Switch quantity setting instructions

设置项目 project	范围 Scope	说明 Notes
DO 通道 DO channel	DO01~DO04	DO 通道选择 DO channel selection
输出选择 Output Sel	报警 1 控制、报警 2 控制、通信控制 Alarm1 Ctr, Alarm2 Ctr, Comm Ctr	DO 控制方式选择 DO control mode selection
通信控制自断开延 时 Comm Ctrl Off Dly	0~9999s	通信控制时有效。设置为 0 时，为电平控制方式，非 0 时为脉冲控制方式，延时设置的时间后断开，单位：s。 Effective in communication control. When it is set to 0, it is the level control mode; when it is not 0, it is the pulse control mode. It is disconnected after the set time of delay, unit: s.
报警对应 DO 使能 Alarm Correspond	见报警类型说明 See Alert type description	
DI01-DI08	常开、常闭 Normally open, normally close	DI 初始化状态，当 DI 状态由初始状态改变，且 DO 关联了该报警，则 DO 动作 DI initializes the state. When the state of DI changes from the initial state and the alarm is associated with DO, the DO action is taken
DI 通道 DI channel	DI01、DI02、DI03、DI04	
默认状态 State	常开、常闭 NO、NC	

注：

Note:

1、举例：当 D01 选择输出控制方式为报警 1 控制或报警 2 控制，且关联了 A 相过流报警和 A 相过功率报警，其余均未关联。设置完成后当 A 相过流或 A 相过功率任意一项报警发生时，D01 动作。

1. For example, when DO1 chooses the output control mode as alarm 1 control or alarm 2 control, and the phase A overcurrent alarm and phase A overpower alarm are associated, the rest are not associated. After setting, when any alarm of phase A overcurrent or phase A overpower occurs, DO1 will act.

2、在选择 DO 关联的报警类型前需确认该报警类型在报警设置中勾选，若未勾选，则该报警条件产生时，DO 也无法动作。

2. Before selecting the alarm type associated with DO, make sure that the alarm type is checked in the alarm setting. If it is not checked, DO will not be able to act when the alarm condition is generated.

8.3.5 AO 设置

8.3.5 AO Settings

在主界面上，按 Menu 进入菜单界面，按 √ 直到“参数设置”高亮显示，按 √ 进入参数设置界面。按 √ 直到“AO 设置”亮显示，按 √ 进入 AO 设置界面。按 ^ 或 √ 切换 AO 设置的项目，按 Enter，进入该项目的设置，按 + 或 - 进行更改，按 > 进行移位，当前项设置更改完成后，按 Exit 退出该项目设置。继续重复上述操作进行修改设置。更改完成后，按 Exit 弹窗输入密码，默认密码为 0001(客户可根据 8.3.8 系统设置之密码设置修改密码，如忘记密码，则需联系我司)。按 Save 则保存修改退出，按 Esc 则不保存修改直接退出。

On the main interface, press "Menu" to enter the menu interface. Press "√" until "Settings" is highlighted, then press "√" to enter the parameter settings interface. Press "√" until "AO Settings" is displayed, then press "√" to enter the AO settings interface. Press "^" or "√" to switch between the items of AO settings, press "Enter" to enter the settings of the current item, press "+ or -" to make changes, press ">" to shift, and after the current item settings are completed, press "Exit" to exit the settings. Repeat the above operations to modify the settings. After the settings are changed, press "Exit" to pop up a window and enter the password. The default password is 0001 (customers can modify the password according to the password settings in the 8.3.8 system. If the password is forgotten, please contact our company). Press "Save" to save the modifications and exit, or press "Esc" to not save the modifications and exit directly.



图 20 模拟量输出设置

Figure 20 Analog output Settings

表 12 AO 设置说明

Table 12 AO Setup Instructions

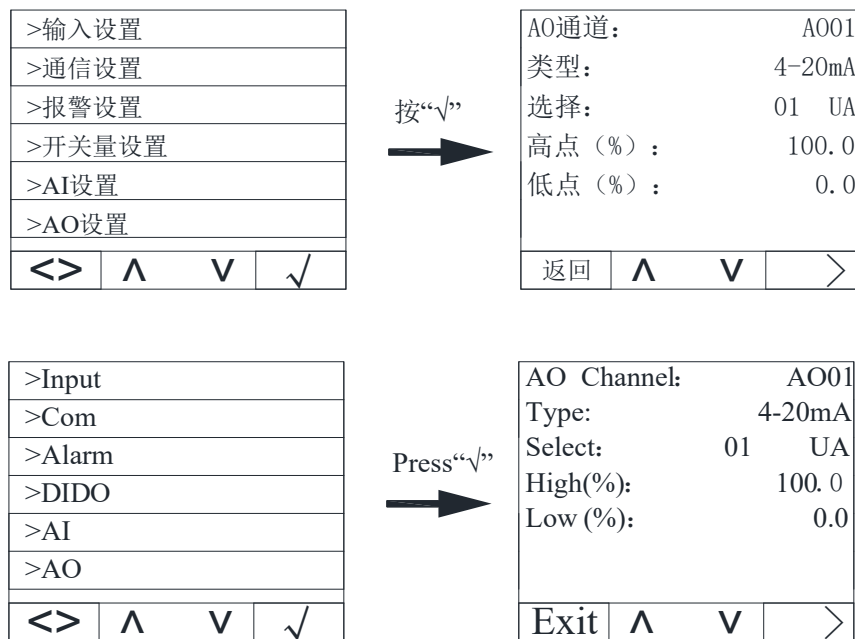
设置项目 Project	范围 Scope	说明 Notes
AO 通道 AO channel	AO01~AO02	模拟量输出通道选择 Analog output channel selection
类型 Types	4-20mA、0-20mA	模拟量输出类型 Analog output type
选择 Selection	见输出对应参数,见注 ¹ See output corresponding parameters, see Remark ¹	可以关联多种参量, 见注 ¹ 。AO 的输出值随着所关联参量的值而变化。若果关联频率, 那么频率改变时, 则 AO 的输出值也随着改变。 A variety of parameters can be associated, see Remark 1. The output value of AO varies with the value of the associated parameter. If the frequency is associated, then when the frequency changes, the AO output will also change.
高点 (%) High point (%)	根据关联信号确定 According to the correlation signal	AO 输出高点对应的参数值 AO outputs the parameter values corresponding to the high points
低点 (%) Low point (%)	根据关联信号确定 According to the correlation signal	AO 输出低点对应的参数值 AO outputs the parameter values corresponding to the low points

注 1

Remark1

表 22 模拟量输出选择对应参数

Table 22 Analog output selection of corresponding parameters

序号 Number	参数 Parameters	序号 Number	参数 Parameters	序号 Number	参数 Parameters
01	UA (A 相电压) A phase voltage	10	PA (A 相有功功率) A phase active power	19	SB (B 相视在功率) B contrast in power
02	UB (B 相电压) B phase voltage	11	PB (B 相有功功率) B phase active power	20	SC (C 相视在功率) C contrast in power
03	UC (C 相电压) C phase voltage	12	PC (C 相有功功率) C phase active power	21	St (总视在功率) total apparent power

04	UAB(AB 线电压) AB line voltage	13	Pt(总有功功率) total active power	22	PFA(A 相功率因数) Phase A Power Factor
05	UBC(BC 线电压) BC line voltage	14	QA(A 相无功功率) A phase reactive power	23	PFB(B 相功率因数) Phase B Power Factor
06	UCA(CA 线电压) CA line voltage	15	QB(B 相无功功率) B phase reactive power	24	PFC(C 相功率因数) Phase C Power Factor
07	IA(A 相电流) Phase A current	16	QC(C 相无功功率) C phase reactive power	25	PF(功率因数) Power Factor
08	IB(B 相电流) B phase current	17	Qt(总无功功率) total reactive power	26	F(频率) frequency
09	IC(C 相电流) C phase current	18	SA(A 相视在功率) A phase in power		

举例：当 AO1 设置为 4-20mA 输出，信号选择为 00 IA(A 相电流)，输出高点对应信号为 5.000A，输出低点对应信号为 0.000A。则当 A 相电流值为 5A 时，AO1 输出为 20mA；当 A 相电流值为 0A 时，AO1 输出为 4mA；当 A 相电流值为 2.5A 时，AO1 输出为 12mA。

Example: When AO1 is set to a 4-20mA output, and the signal selection is 00 IA (phase A current), the output high point corresponds to a signal of 5.000A, and the output low point corresponds to a signal of 0.000A. Then when the current of phase A is 5A, AO1 outputs 20mA; when the current of phase A is 0A, AO1 outputs 4mA; when the current of phase A is 2.5A, AO1 outputs 12mA.

8.3.6 复费率设置

8.3.6 Multi rate

在主界面上，按 Menu 进入菜单界面，按 √ 直到“参数设置”高亮显示，按 √ 进入参数设置界面。按 √ 直到“复费率设置”亮显示，按 √ 进入复费率设置界面。按 ∧ 或 ∨ 切换复费率设置的项目，按 Enter，进入该项目的设置，按 + 或 - 进行更改，按 > 进行移位，当前项设置更改完成后，按 Exit 退出该项目设置。继续重复上述操作进行修改设置。更改完成后，按 Exit 弹窗输入密码，默认密码为 0001(客户可根据 8.3.8 系统设置之密码设置修改密码，如忘记密码，则需联系我司)。按 Save 则保存修改退出，按 Esc 则不保存修改直接退出。

On the main interface, press Menu to enter the menu interface, press √ until "Settings" is highlighted, and press √ to enter the parameter setting interface. Press √ until "Multi rate" is displayed, and press √ to enter the complex rate setting interface. Press ∧ or ∨ to switch the item of complex rate setting, press Enter to enter the setting of the item, press + or - to change, press > to shift, and press Exit to exit the item setting after the change of the current item

setting is completed. Go ahead and repeat to change the Settings. After the change is completed, press the Exit pop-up window to enter the password. The default password is 0001(Customers can change the password according to the password Settings set in 8.3.8 system. If they forget the password, they need to contact our company). Press Save to exit with the changes saved, and press Esc to exit without saving the changes.

a 时区组选择设置

a Time zone group selection Settings



图 21 时区组选择示意图

Figure 21 Diagram of time zone group selection

注: T1-T5: 尖、峰、平、谷、深谷, T6-T8: 预留

NOTE: T1-T5: sharp, peak, flat, valley, deep valley, T6-T8: Reserved

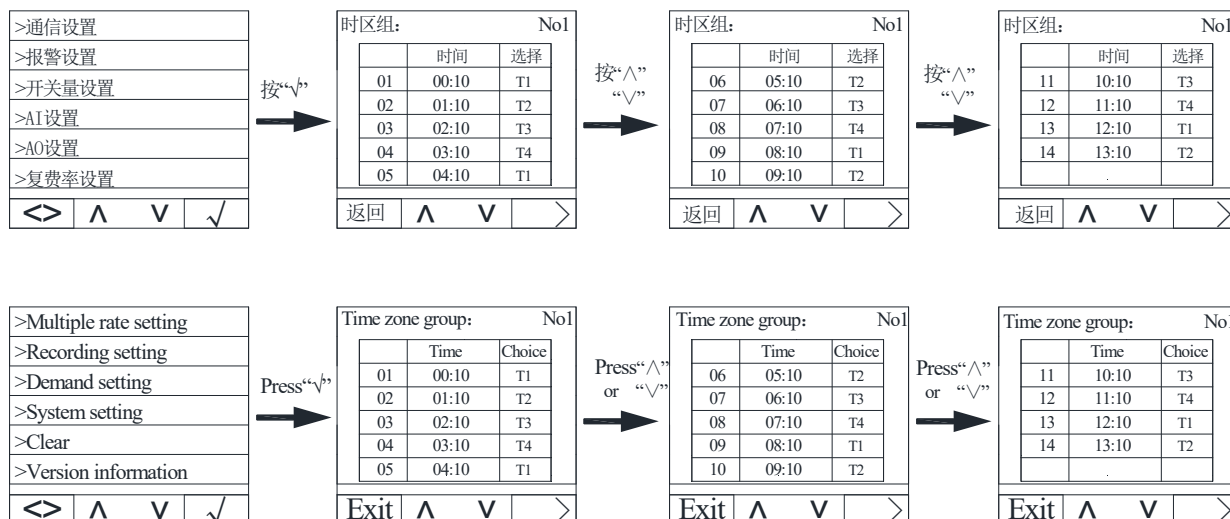
每个时段分成 14 个区间, 详细描述见下表

Each time period is divided into 14 intervals, which are described in detail in the following table

表 13 时段设置示例

Table 13 Time period setting Example

序号 Number	时间 Time	选择 Selection	描述 Notes
01	00:00	T3	表示在 00:00 到 01:00 时间段中, 费率为平 The rate during 00:00 to 01:00 is categorized as flat
02	01:00	T3	表示在 01:00 到 03:00 时间段中, 费率为平 The rate during 01:00 to 03:00 is categorized as flat
03	03:00	T3	表示在 03:00 到 05:00 时间段中, 费率为平 The rate during 03:00 to 05:00 is categorized as flat
04	05:00	T3	表示在 05:00 到 07:00 时间段中, 费率为平 The rate during 05:00 to 07:00 is categorized as flat

05	07:00	T2	表示在 07:00 到 09:00 时间段中，费率为峰 The rate during 07:00 to 09:00 is categorized as peak
06	09:00	T2	表示在 09:00 到 10:00 时间段中，费率为峰 The rate during 09:00 to 10:00 is categorized as peak
07	10:00	T1	表示在 10:00 到 12:00 时间段中，费率为尖 The rate during 10:00 to 12:00 is categorized as sharp
08	12:00	T1	表示在 12:00 到 13:00 时间段中，费率为尖 The rate during 12:00 to 13:00 is categorized as sharp
09	13:00	T1	表示在 13:00 到 15:00 时间段中，费率为尖 The rate during 13:00 to 15:00 is categorized as sharp
10	15:00	T2	表示在 15:00 到 17:00 时间段中，费率为峰 The rate during 15:00 to 17:00 is categorized as peak
11	17:00	T2	表示在 17:00 到 19:00 时间段中，费率为峰 The rate during 17:00 to 19:00 is categorized as peak
12	19:00	T2	表示在 19:00 到 21:00 时间段中，费率为峰 The rate during 19:00 to 21:00 is categorized as peak
13	21:00	T4	表示在 21:00 到 23:00 时间段中，费率为谷 The rate during 21:00 to 23:00 is categorized as valley
14	23:00	T4	表示在 23:00 到 00:00 时间段中，费率为谷 The rate during 23:00 to 00:00 is categorized as valley

注：手动设置或通讯写入费率时段时必须保证下一时段所设置的时间大于上一时段所设置的时间。

b 切换日期设置

b Toggle date Settings

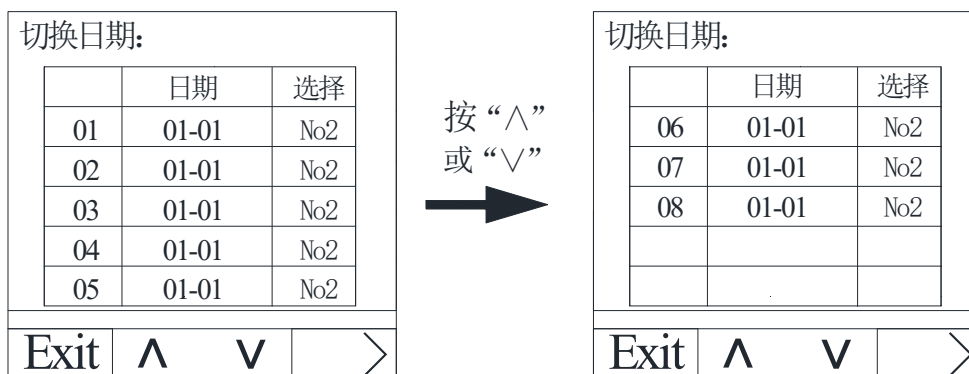



图 22 日期切换设置

Figure 22 Date switching Settings

切换日期设置，最多可设 8 个日期段，举例描述见下表。

Toggle the date setting, up to 8 date segments can be set. See the table below for an example description.

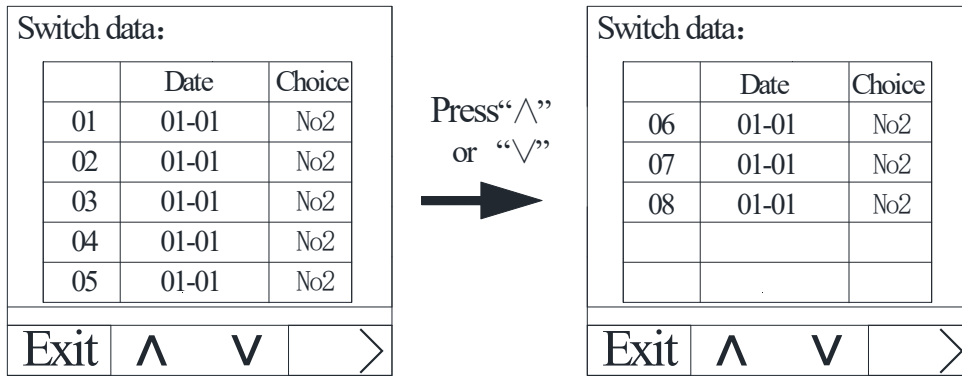
表 14 日期段设置示例

Table 14 Example date segment Settings

序 号 Number	日期 Date	选择 Selection	描述 Notes
01	01-01	No1	表示在 1 月 1 日到 3 月 1 日间，采用时段 1 计算复费率电能 Jan 1–Mar 1: Time Block 1 for multi-rate energy
02	03-01	No2	表示在 3 月 1 日到 5 月 1 日间，采用时段 2 计算复费率电能 Mar 1–May 1: Time Block 2 for multi-rate energy.
03	05-01	No2	表示在 5 月 1 日到 7 月 1 日间，采用时段 2 计算复费率电能 May 1–Jul 1: Time Block 2 for multi-rate energy.
04	07-01	No3	表示在 7 月 1 日到 9 月 1 日间，采用时段 3 计算复费率电能 Jul 1–Sep 1: Time Block 3 for multi-rate energy.
05	09-01	No3	表示在 9 月 1 日到 11 月 1 日间，采用时段 3 计算复费率电能 Sep 1–Nov 1: Time Block 3 for multi-rate energy.
06	11-01	No4	表示在 11 月 1 日到 1 月 1 日间，采用时段 4 计算复费率电能 Nov 1–Jan 1: Time Block 4 for multi-rate energy.
07			
08			

8.3.7 需量设置

8.3.7 Demand

在主界面上，按 Menu 进入菜单界面，按 v 直到“参数设置”高亮显示，按 √ 进入参数设置界面。按 v

直到“需量设置”高亮显示，按 \checkmark 进入需量设置界面。按 \wedge 或 \vee 切换需量设置的项目，按 Enter ，进入该项目的设置，按 $+$ 或 $-$ 进行更改。更改完成后，按 Exit，弹窗输入密码，按 Save 则保存修改退出，按 Esc 则不保存修改直接退出。

On the main interface, press Menu to enter the menu interface, press \vee until "Settings" is highlighted, and press \checkmark to enter the parameter setting interface. Press \vee until "Demand Setting" is highlighted, and press \checkmark to enter the demand setting interface. Press \wedge or \vee to switch the item of demand setting, press Enter to enter the setting of the item, and press $+$ or $-$ to make changes. After the change is completed, press Exit and enter the password in the pop-up window. Press Save to save the change and Exit, and press Esc to exit without saving the change.



图 23 需量设置界面

Figure 23 Demand setting interface

表 15 需量设置说明

Table 15 Demand setting instructions

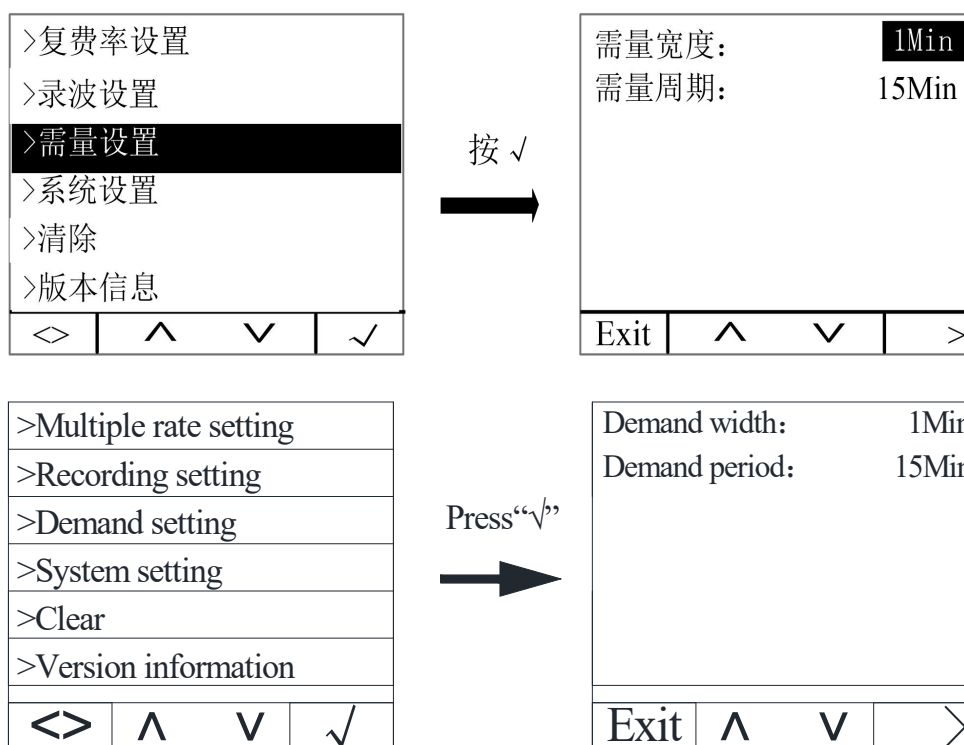
设置项目 Project	范围 Scope
需量宽度 Demand width	1, 2, 3, 5Min
需量周期 Demand period	5-60Min(根据需量宽度进行设置,必须是需量宽度的整数倍 set according to the required width, which must be an integer multiple of the required width)

需量计算方法:

Demand calculation method:

APM 系列仪表采用滑窗式方法计算需用量。在滑窗计算周期，选择一个计算周期和一个滑窗窗口。滑窗窗

口必须均分计算周期。例如:在 15 分钟的计算周期设定 3 个 5 分钟的滑动窗口。在每个滑动窗口结束时刷新当前需用量。示意图如下图:

The APM series meter uses the sliding window method to calculate the required amount. In the sliding window calculation period, a calculation period and a sliding window window are selected. The sliding window window must equally divide the computation period. For example: three sliding Windows of 5 minutes on a 15 minute computation period. The current demand is refreshed at the end of each sliding window. The diagram is as follows:



图 24 需量计算示意图

Figure 24 Schematic diagram of demand calculation

8.3.8 系统设置

8.3.8 System Settings

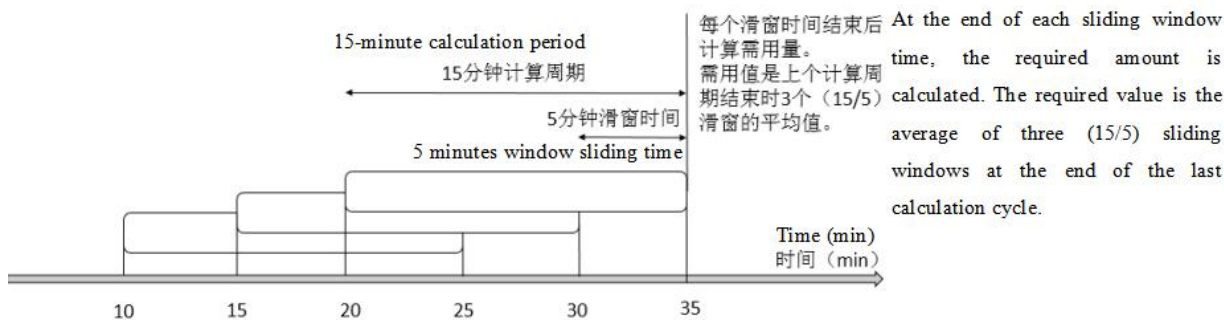
在主界面上,按 Menu 进入菜单界面,按 √ 直到“参数设置”高亮显示,按 √ 进入参数设置界面。按 √ 直到“系统设置”高亮显示,按 √ 进入需量设置界面。按 ^ 或 ∨ 切换系统设置的项目,按 Enter, 进入该项目的设置,按 + 或 - 进行更改。更改完成后,按 Exit, 弹窗输入密码,按 Save 则保存修改退出,按 Esc 则不保存修改直接退出。

On the main interface, press Menu to enter the menu interface, press √ until "Settings" is highlighted, and press √ to enter the parameter setting interface. Press √ until "System" is highlighted, and press √ to enter the system setting interface. Press ^ or ∨ to switch the item of demand setting, press Enter to enter the setting of the item, and press + or - to make changes. After the change is completed, press Exit and enter the password in the pop-up window. Press Save to save the change and Exit, and press Esc to exit without saving the change.

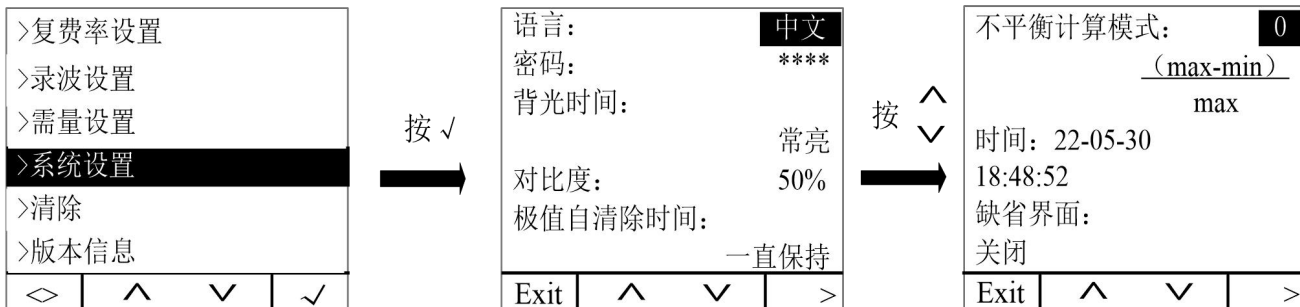



图 25 系统设置界面
Figure 25 System Setup interface

表 16 系统设置说明
Table 16 System setup description

设置项目 Project	范围 Scope	说明 Note
语言 Language	中文、English, 仪表出厂设置默认为中文 Chinese, English, instrument factory Settings default to Chinese	更改仪表显示语言 Change the instrument display language
密码 Password	0000~9999, 仪表出厂默认为 0001, 客户可自行修改设置, 如忘记密码, 则需联系我司 0000~9999, the instrument factory default is 0001, customers can modify the setting, if forget the password, you need to contact our company	需输入原密码后进行更改 You need to enter the original password to change it
背光时间 Backlight time	常亮、1~9999, 仪表默认为常亮 Constant light, 1~9999, the instrument defaults to constant light	1~9999: 在延时该设置值后, 背光熄灭, 单位为秒。 1~9999: After delaying the setting value, the backlight goes off in seconds.
对比度 Contrast ratio	1~99%, 仪表默认为 50% 1~99%, and the meter defaults to 50%	更改仪表显示对比度, 默认为 50% Change the meter display contrast to 50% by default
极值自清除时间 Extreme self-clearing time	一直保持、每月重新统计、每天重新统计、每小时重新统计、每 30 分钟重新统计、每 15 分钟重新统计, 仪表默认为一直保持 Always on, monthly recount, daily recount, hourly recount, every	极值统计时间 Extreme value statistics time

	30 minutes recount, every 15 minutes recount, the meter defaults to always on	
不平衡计算模式 Imbalanced computation mode	$0 = \frac{\max - \min}{\max}$ $1 = \frac{\max \{ A - \text{avg} , B - \text{avg} , C - \text{avg} \}}{\text{ave}}$ $2 = \frac{\max \{ A - \text{ave} , B - \text{ave} , C - \text{ave} \}}{\text{rating}}$ <p>上述算法中 In the above algorithm</p> <p>算法 0 参照 Q/GDW 1519-2014 Algorithm 0 refers to Q/GDW 1519-2014</p> <p>算法 1 参照 IEEE std 1159 1995-RECOMMENDED PRACTICE FOR MONITORING ELECTRIC POWER QUALITY Algorithm 1 refers to IEEE std 1159 1995-RECOMMENDED PRACTICE FOR MONITORING ELECTRIC POWER QUALITY</p> <p>算法 2 我司自定 Algorithm 2 is customized by our company</p> <p>A、B、C 为：各相有效值 A, B and C are: the effective values of each phase</p> <p>A'、B'、C'为：各相向量 A', B' and C' are: each phase vector</p> <p>max 为：三相最大值 max is: the maximum value of the three phases</p> <p>min 为：三相最小值 min is: the minimum value of the three phases</p> <p>avg 为：三相平均值 avg is the average of three phases</p> <p>rating 为：额定值 Rating value 仪表默认为 0 The meter defaults to 0</p>	<p>3 种不同不平衡算法,客户可根据需求进行设置。另外,需要注意的是不平衡度计算是一个相对百分数,计算是应同时考虑负载率的大小,对于负载率较小工况下不平衡计算值较大,其造成的影响和危害较小。</p> <p>3 different imbalance algorithms, customers can set according to their needs. In addition, it should be noted that the calculation of imbalance degree is a relative percentage, and the calculation should consider the size of the load rate at the same time. The calculation value of imbalance under the condition of small load rate is large, and the impact and harm caused by it are small.</p>
时间 Time	yy-mm-dd hh:mm:ss	显示格式为年、月、日、时、分、秒

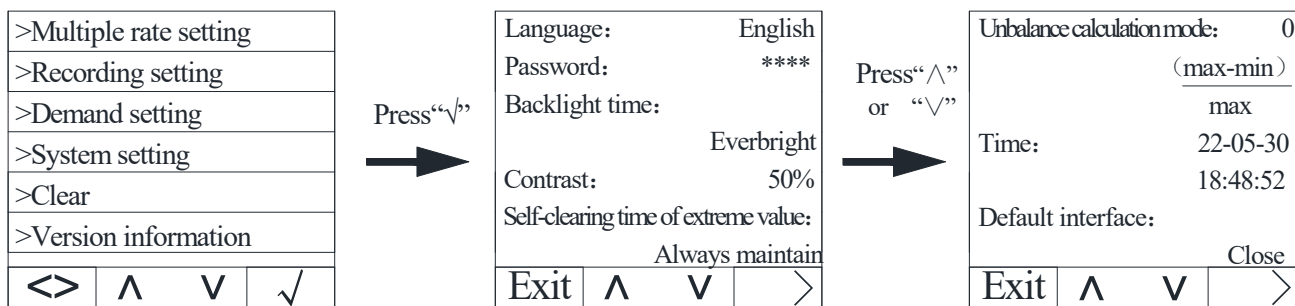
		The display format is year, month, day, hour, minute, and second
缺省界面 The default screen	关闭(默认为关闭) 概览、当前线电压、当前电流、频率、总功率、有功功率需量、有功电能、无功电能、视在电能、总正向付费率电能、总反向付费率电能、电流总谐波、电压总谐波、矢量图、电压序分量、电流序分量、DIDO 事件记录、当前报警状态 Close (closed by default) Overview, Current line voltage, current current, frequency, total power, active power demand, active power, reactive power, apparent power, Total forward payment rate power, Total reverse payment rate power, total current harmonic, total voltage harmonic, vector diagram, voltage sequence component, current sequence component, DIDO event record, Current alarm state,	仪表在无任何操作 1 分钟后，跳转回到主界面，仪表断电后 After 1 minute without any operation, the meter jumps back to the main interface, after the meter power off

8.3.9 清除设置

8.3.9 Clear

在主界面上，按 Menu 进入菜单界面，按 ∨ 直到“参数设置”高亮显示，按 √ 进入参数设置界面。按 ∨ 直到“清除设置”高亮显示，按 √ 进入清除设置界面。按 ∧ 或 ∨ 切换清除设置的项目，按 Enter ，弹窗输入密码，按 Exit 等待清除完毕，按 Esc 清除该项目数据，按 Exit 退出。

On the main interface, press Menu to enter the menu interface, press ∨ until "Settings" is highlighted, and press √ to enter the parameter setting interface. Press ∨ until "Clear" is highlighted, and press √ to enter the clear Settings interface. Press ∧ or ∨ to switch to clear the set items, press Enter to enter the password in the pop-up window, press Exit to wait for the completion of clearing, press Esc to clear the data of the project, and press Exit to exit.

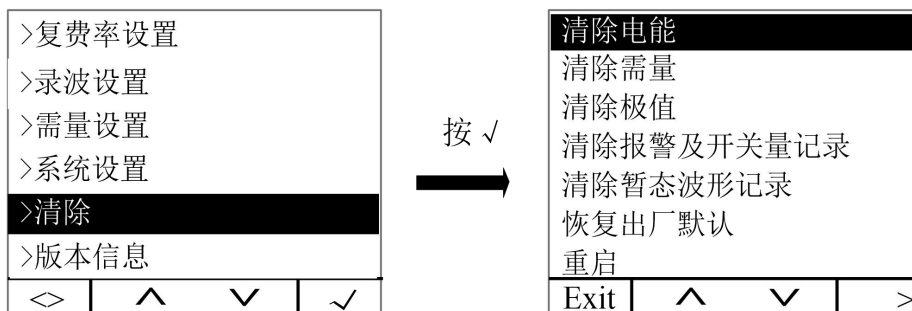



图 26 清除设置界面

Figure 26 Clear the Settings screen

表 17 清除功能说明

Table 17 Clear function Description

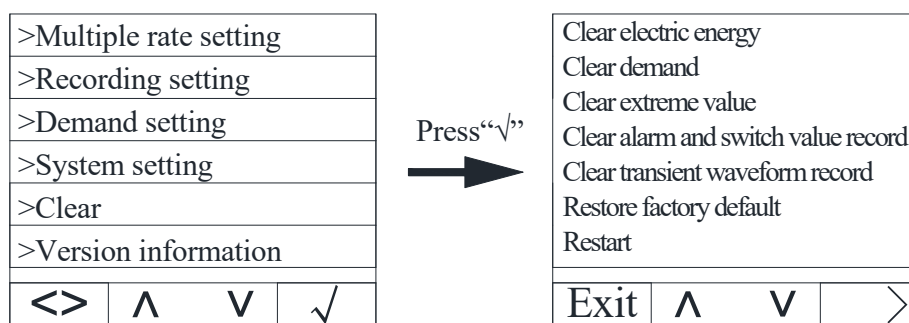
项目 Project	说明 Notes
清除电能 Clear electrical energy	清除电能 Clear electrical energy
清除需量 Clearance demand	清除功率需量、电流需量 Clear the power demand and current demand
清除极值 Clear extreme values	清除电压、电流等电参量的最大、最小值记录 Clear the maximum and minimum value records of electrical parameters such as voltage and current
清除报警及开关量记录 Clear the alarm and switch quantity records	清除报警记录及开关量记录 Clear the alarm records and switch quantity records
清除暂态波形记录 Clear the transient waveform record	清除电压中断、暂升、暂降、冲击电流等暂态波形记录 Clear the records of transient waveforms such as voltage interruption, transient rise, transient fall, and inrush current
恢复出厂默认 Restore factory Defaults	恢复出厂默认 Restore factory Defaults
重启 Restart	重启 Restart

8.3.10 版本信息

8.3.10 Version information

在主界面上，按 Menu 进入菜单界面，按 v 直到按参数设置高亮显示，按 √ 进入参数设置界面。按 v 直到“版本信息”高亮显示，按 √ 进入版本信息。包含仪表版本信息、模块版本信息、仪表表内部温度、运行时间、带载时间及空载时间。

On the main interface, press Menu to enter the menu interface, press v until the ‘Settings’ are highlighted, and

press \checkmark to enter the parameter Settings interface. Press \checkmark until "Version" is highlighted, and press \checkmark to enter the version information. It includes the version information of the instrument, the version information of the module ,the internal temperature of the instrument,run time, load time and no-load time.



图 27 版本信息界面
Figure 27 Version information screen

8. 3. 11 相序调整

8. 3. 11 Adjustment of Phase Sequence

在主界面上, 按 Menu 进入菜单界面, 按 \checkmark 直到“参数设置”高亮显示, 按 \checkmark 进入参数设置界面。按 \checkmark 直到“相序调整”高亮显示, 按 \checkmark 进入需量设置界面。按 \wedge 或 \vee 切换需量设置的项目, 按 Enter , 进入该项目的设置, 按 + 或 - 进行更改。更改完成后, 按 Exit, 弹窗输入密码, 按 Save 则保存修改退出, 按 Esc 则不保存修改直接退出。

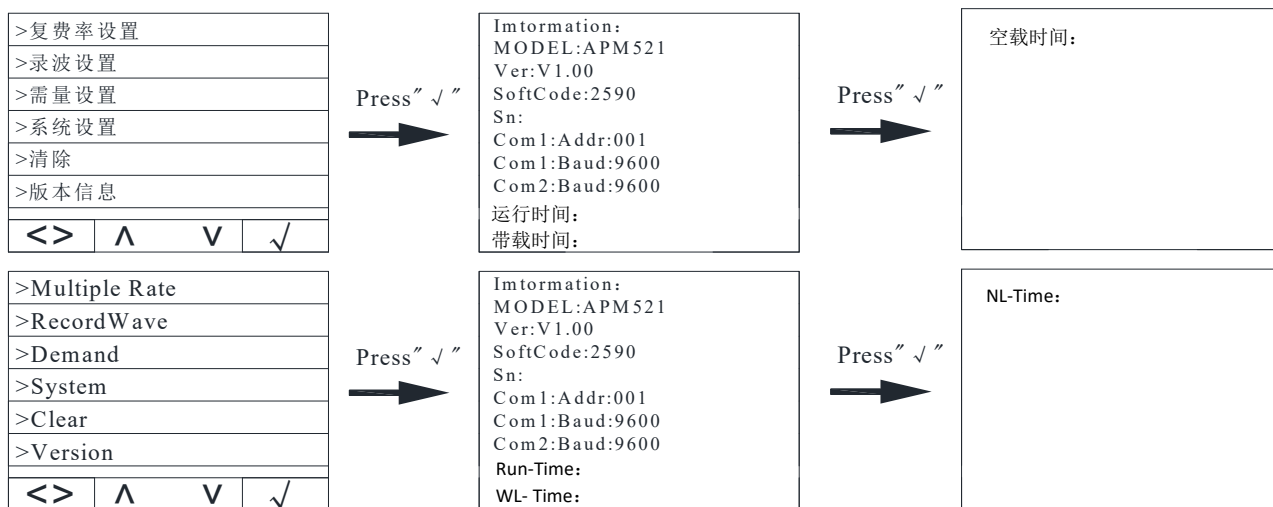
On the main interface, press Menu to enter the menu interface, press \checkmark until "Settings" is highlighted, and press \checkmark to enter the parameter setting interface. Press \checkmark until "Phase Setting" is highlighted, and press \checkmark to enter the demand setting interface. Press \wedge or \vee to switch the item of demand setting, press Enter to enter the setting of the item, and press + or - to make changes. After the change is completed, press Exit and enter the password in the pop-up window. Press Save to save the change and Exit, and press Esc to exit without saving the change.



图 28 相序调整界面

Figure 28 Phase sequence adjustment interface

表 18 相序调整功能说明

Table 18 Phase sequence adjustment function description

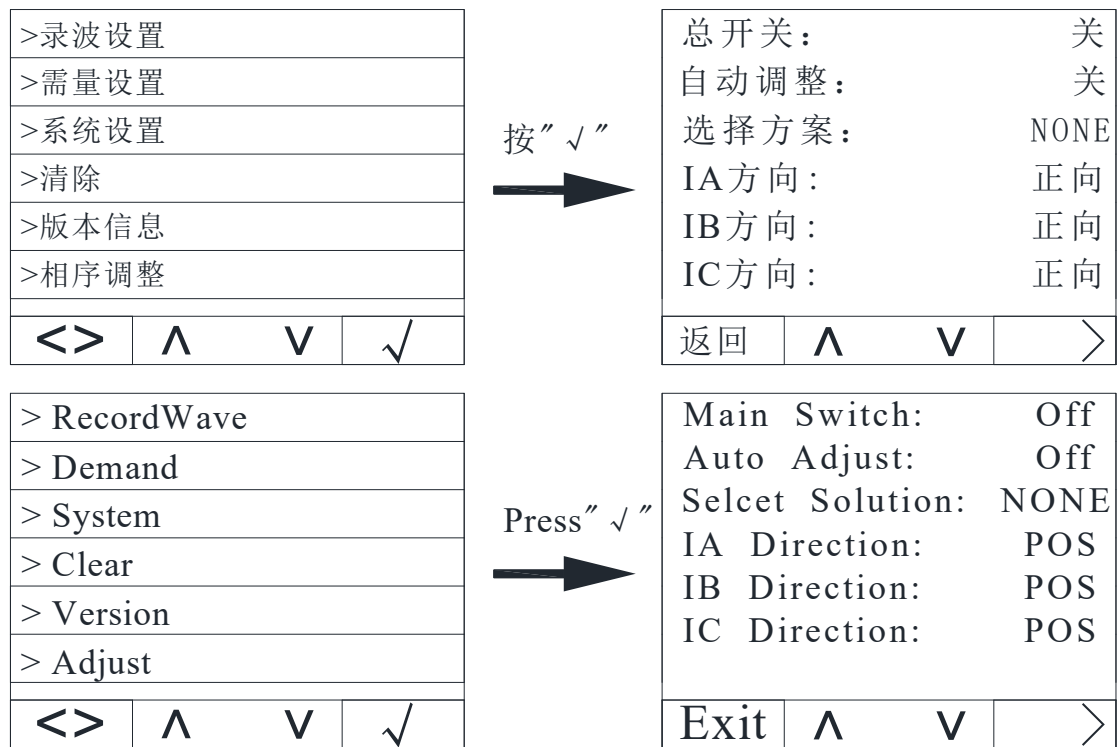
设置项目 Project	范围 Scope	说明 Notes
总开关 Main Switch	开、关 On、Off	下方设置生效与否开关，默认关闭 The lower setting is effective or not switch, the default is off
自动调整 Auto Adjust	开、关 On、Off	自动识别相序，调整至正确相序，默认关闭 Automatically identify the phase sequence, adjust to the correct phase sequence ,the default is off
选择方案 Selcet Solution	NONE、BAC、CBA、 ACB、BCA、CAB	三相相序实际方案，默认 NONE Three-phase phase sequence practical scheme
IA 方向 IA Direction	正向、反向 POS、NEG	A 相电流方向，默认正向 Phase A current direction, the default is POS
IB 方向 IB Direction	正向、反向 POS、NEG	B 相电流方向，默认正向 Phase B current direction, the default is POS
IC 方向 IC Direction	正向、反向 POS、NEG	C 相电流方向，默认正向 Phase C current direction, the default is POS

9 通信说明

9 Communication Instructions

仪表 RS485 通信接口支持 MODBUS-RTU 通信协议,通信口波特率可在 1200bps、2400 bps、4800 bps、9600bps、19200 bps 和 38400 bps 之间设置,校验位为无校验。

The instrument RS485 communication interface supports MODBUS-RTU communication protocol. The baud rate of communication interface can be set between 1,200bps, 2,400 bps, 4,800 bps, 9,600bps, 19,200 bps and 38,400 bps, and the check bit is no check.

仪表的 RS485 通信口要求使用屏蔽双绞线连接,布线时要考虑整个网络的布局:如通信线缆的长度、走向、上位机的位置、网络末端的匹配电阻、通信转换器、网络可扩展性、网络覆盖范围、环境的电磁干扰情况等因素,都要综合考虑。

The RS485 communication interface of the instrument requires shielded twisted pair connection, and the layout of the whole grid should be considered when wiring: For example, the length and direction of communication cable, the position of upper computer, the matching resistance at the end of the grid, the communication converter, the scalability of the grid, the coverage of the grid, the electromagnetic interference of the environment and other factors should be considered comprehensively.

注:

Note:

- 1、在布线工程上要严格按要求施工;
1. It shall strictly construct according to the requirements in the wiring project;
- 2、对于暂时不需要通信的仪表都要将他们连接到 RS-485 网络上,以便于诊断和测试;
2. For instruments that do not need communication temporarily, they should be connected to RS-485 grid for diagnosis and test;
- 3、进行 RS-485 电缆连接时,尽量使用双色双绞线,所有的 485 通信口“A”端接同一种颜色,“B”端接另一种颜色。
3. When connecting RS-485 cable, try to use two-color twisted pair. All 485 communication ports "A" are terminated in the same color, and "B" is terminated in another color.
- 4、RS-485 总线(从上位机通信口开始到任一被连接的仪表终端通信口)长不超过 1000 米。
4. The length of RS-485 bus (from the communication interface of the upper computer to any connected instrument terminal communication interface) shall not exceed 1,000 meters.

9.1 地址表

9.1 Address Table

仪表支持 MODBUS-RTU 协议中的 03H 命令与 10H 命令,03H 为读多个寄存器,10H 为写多个寄存器,协议数据格式请自行查询。下表为仪表的寄存器地址表:

Meter supports 03H command and 10H command in MODBUS-RTU protocol, in which 03H for reading multiple registers and 10H for writing multiple registers. Please check the protocol data format by yourself. The following table is the register address table of the meter:

表 19 地址表

Table 19 Address table

地址	名称	解释	R/W	字长	类型	备注
Address	Name	Explanation		Word	Type	Note

0x1000	Addr1	地址 1 Address 1	R/W	1	Uint16	1-247
0x1001	Baud1	波特率 1 Baud rate 1	R/W	1	Uint16	1200, 2400, 4800, 9600, 19200, 38400bps。
0x1002	Check1	校验位 1 Check bit 1	R/W	1	Uint16	低字节 Low byte 0: 无校验 No check 1: 奇校验 Odd check 2: 偶校验 Even check 高字节 High byte 0: 1 停止位 1 stop bit 1: 1.5 停止位 1.5 Stop bit 2: 2 停止位 2 Stop bit
0x1004	Baud2	波特率 2 Baud rate 2	R/W	1	Uint16	1200, 2400, 4800, 9600, 19200, 38400bps
0x1005	Check2	校验位 2 Check bit 2	R/W	1	Uint16	低字节 Low byte 0: 无校验 No check 1: 奇校验 Odd check 2: 偶校验 Even check 高字节 High byte 0: 1 停止位 1 stop bit 1: 1.5 停止位 1.5 Stop bit 2: 2 停止位 2 Stop bit
0x1006	645Addr	645 地址 645 address	R/W	3	Uint16	BCD 码高位在前 The high bits of the BCD code are at the front
0x1009	SnNum	序列号 Serial number	R/W	7	Ascii	14 个 ASCII 码 Fourteen ASCII codes
0x1010	Line	接线方式	R/W	1	Uint16	0:3P4L 1:3P3L

		Wiring method				
0x1011	UbTwoSide	电压二次额定值 Secondary rated value of voltage	R/W	1	Uint16	一位小数 V One decimal place V
0x1012	IbTwoSide	电流二次额定值 Secondary rated value of current	R/W	1	Uint16	两位小数 A Two decimal places A
0x1013	InTwoSide	中性线电流二次额定值 Secondary rated value of neutral line current	R/W	1	Uint16	两位小数 A Two decimal places A
0x1015	UbOneSide	电压一次额定值 Primary rated voltage	R/W	1	Uint32	一位小数 V One decimal place V
0x1017	IbOneSide	电流一次额定值 Primary rated value of current	R/W	1	Uint32	两位小数 A Two decimal places A
0x1019	InOneSide	中性线电流一次额定值 The primary rated value of neutral line current	R/W	1	Uint32	两位小数 A Two decimal places A
0x101D	Password	密码 Password	R/W	1	Uint16	1-9999
0x101E	Pluse	脉冲常数 Pulse constant	R/W	1	Uint16	默认 6400
0x101F	UShield	电压屏蔽 Voltage shielding	R/W	1	Uint16	0~655.35%
0x1020	IShield	电流屏蔽 Current shielding	R/W	1	Uint16	0~655.35%
0x1021	InShield	中性线电流屏蔽 Neutral line current shielding	R/W	1	Uint16	0~655.35%
0x1023	DisPage	固定显示页面或动态显示	R/W	1	Uint16	0: 动态 (Dynamic)

		Fixed display page or dynamic display				1, 2, 3
0x1024	Language	语言 Language	R/W	1	Uint16	0: 英语 English 1: 汉语 Chinese
0x1025	DemandWidth	需量宽度 Demand width	R/W	1	Uint16	单位 (Unit) min (1-5)
0x1026	DemandPeriod	需量周期 Demand cycle	R/W	1	Uint16	单位 (Unit) min (1-30)
0x102E	BlackTime	背光时间 Backlight time	R/W	1	Uint16	0:常亮 Constantly on 1: 1min 2:2min
0x102F	SysTime	时间 Time	R/W	5	Uint16	年 Year, 月 Month, 日 Day, 星期 Week, 时 Hour, 分 minute, 秒 second, 毫秒 Milliseconds
0x1034	CopyTime	自动抄表日 Automatic Meter Reading Day	R/W	1	Uint16	高字节 High byte : 日 Day 低字节 Low byte: 时 Hour
0x1036	DOState	DO 状态 DO state	R/W	1	Uint16	Bit0:DO1 Bit1: DO2... 0: 打开 Turn On 1: 闭合 Turn Off
0x1037	DIState	DI 状态 DI state	R	1	Uint16	Bit0:DI1 Bit1: DI2... 0: 打开 Turn On 1: 闭合 Turn Off
0x1038	ZoneNum1, ZoneMonth1, ZoneDay1 ZoneNum2, ZoneMonth2, ZoneDay2	第一时区时段表号 Time period table number of the first time zone: 第一时区开始月 The beginning month of the first time zone,	R/W	12	Uint16	时段表号 Time period table number: 第 1 时段 Period 1, 第 2 时段 Period 2, 第 3 时段 Period 3,

<p>neDay2 ZoneNum3, ZoneMonth3, ZoneDay3 neDay3 ZoneNum4, ZoneMonth4, ZoneDay4 neDay4 ZoneNum5, ZoneMonth5, ZoneDay5 neDay5 ZoneNum6, ZoneMonth6, ZoneDay6 neDay6 ZoneNum7, ZoneMonth7, ZoneDay7 neDay7 ZoneNum8, ZoneMonth8, ZoneDay8 neDay8</p>	<p>第一时区日 First Time Zone day 第二时区时段表号 Second time zone period table number: 第二时区开始月 The starting month of the second time zone, 第二时区日 Second Time Zone Day 第三时区时段表号 Time period table number of the third time zone: 第三时区开始月 The beginning month of the third time zone, 第三时区日 The third Time zone day 第四时区时段表号 Fourth time zone period table number: 第四时区开始月 The starting month of the fourth time zone, 第四时区日 The Fourth Time Zone day 第五时区时段表号 Time period table number of the fifth time zone: 第五时区开始月 The starting month of the fifth time zone, 第五时区日 The Fifth Time Zone day 第六时区时段表号 Time period table number of the sixth time zone: 第六时区开始月 The month when</p>				<p>第 4 时段 Period 4, 开始月 Starting month: 1-12 January - December 开始日 Start date: 1-31</p>
---	--	--	--	--	--

		<p>the sixth time zone begins, 第六时区日 The sixth Time Zone day</p> <p>第七时区时段表号 Time period table number of time Zone 7:</p> <p>第七时区开始月 The month when the seventh time zone begins, 第七时区日 Time Zone seventh Day</p> <p>第八时区时段表号 Time period table number of the eighth time zone:</p> <p>第八时区开始月 The starting month of the eighth time zone, 第八时区日 The eighth Time Zone Day</p>				
0x1044	Table1 Rt1~Rt14	<p>第一套时段表， 每个时段占用三个字节， 分别为费率，开始时，开始分 The first set of time period tables Each period occupies three bytes. They are respectively the rates. At the beginning, the distribution starts</p>	R/W	21	Uint16	<p>费率 Rate: 0 1尖 tip, 2峰 peaks 3平 levels, 4谷 grains 开始时 At the beginnin:0-23 开始分 Starting score: 1-59</p>
0x1059	Table2 Rt1~Rt14	<p>第二套时段表， 每个时段占用三个字节， 分别为费率，开始时，开始分 The second set of time period tables</p>	R/W	21	Uint16	<p>同第一套时段表 The same as the first set of time schedule</p>

		Each period occupies three bytes. They are respectively the rates. At the beginning, the distribution starts				
0x106E	Table3 Rt1~Rt14	第三套时段表, 每个时段占用三个字节, 分别为费率, 开始时, 开始分 The third set of time period tables Each period occupies three bytes. They are respectively the rates. At the beginning, the distribution starts	R/W	21	Uint16	同第一套时段表 The same as the first set of time schedule
0x1083	Table4 Rt1~Rt14	第四套时段表, 每个时段占用三个字节, 分别为费率, 开始时, 开始分 The fourth set of time period tables Each period occupies three bytes. They are respectively the rates. At the beginning, the distribution starts	R/W	21	Uint16	同第一套时段表 The same as the first set of time schedule
AO 设置参数 AO setting parameters						
0x10C0	AoSet1 AoHValue1 AoLValue1	A01 参数设置 H:变送类型 L:信号选择 高点对应值	R/W	3	Uint16	信号选择 Signal selection: 0: A相电压

		<p>低点对应值</p> <p>A01 parameter Settings</p> <p>H: Transmission type L: Signal selection</p> <p>High point corresponding value</p> <p>Low point corresponding value</p>				<p>Phase A voltage</p> <p>1: B相电压</p> <p>Phase B voltage</p> <p>2: C相电压</p> <p>Phase C voltage</p> <p>3: A线电压</p> <p>Voltage of Line A</p> <p>4: B线电压</p> <p>Voltage of Line B</p> <p>5: C线电压</p> <p>Voltage of Line C</p> <p>6: A相电流</p> <p>Phase A current</p> <p>7: B相电流</p> <p>Phase B current</p> <p>8: C相电流</p> <p>Phase C current</p> <p>9: A相有功</p> <p>Phase A active power</p> <p>10: B相有功</p> <p>Phase B active power</p> <p>11: C相有功</p> <p>Phase C active power</p> <p>12: 总有功</p> <p>Total active power</p> <p>13: A相无功</p> <p>Phase A reactive power</p> <p>14: B相无功</p> <p>Phase B reactive power</p>
--	--	---	--	--	--	--

						<p>15: C相无功 Phase C reactive power</p> <p>16: 总无功 Total reactive power</p> <p>17: A相视在 A phase apparent power</p> <p>18: B相视在 B phase apparent power</p> <p>19: C相视在 C phase apparent power</p> <p>20: 总视在 Total apparent power</p> <p>21: A相功率因数 Phase A power factor</p> <p>22: B相功率因数 B phase power factor</p> <p>23: C相功率因数 C phase power factor</p> <p>24: 总功率因数 Total power factor</p> <p>25: 频率 frequency 类型 TYPE: 0: 4-20mA 1: 0-20mA 2: 1-5V 3: 0-5V 4: 0-10V 高点值 High point value: -120.0%~+120.0% 低点值 Low point value: --120.0%~+120.0%</p>
0x10C3	AoSet2	A02 参数设置	R/W	3	Uint16	同 A01 参数设置

		A02 Parameter setting				Same as A01 parameter setting
D0 设置参数 D0 Set parameters						
0x1100	<u>D01Set</u>	<u>0: 远控模式</u>				D0Set: 0:远控 Remote control 1: 报警 alarm 1 2: 报警 alarm 2
	<u>D01Width</u>	<u>Remote control mode</u>				
	D01AlarmRel evance1	<u>1: 关联报警 1</u> <u>Correlation alert 1</u>				
	D01AlarmRel evance2	<u>0:保持 hold</u> <u>1: 脉冲 pulse (仅远控</u>				
	D01AlarmRel evance3	<u>Remote control only)</u> 关联报警从低至高位与报警段设				
	D01AlarmRel evance4	置顺序一致 The associated alarm is set in				
	D01AlarmRel evance5	the same order as the alarm				
	D01AlarmRel evance6	segment from low to high 关联报警 Correlation alarm	R/W	16	Uint16	
	D01AlarmRel evance7	0-15 位 0: 否 NO 1: 是 YES				
	D01AlarmRel evance8	关联报警 Correlation alarm				
	D01AlarmRel evance9	16-31 位 0: 否 NO 1: 是 YES				
	D01AlarmRel evance10	关联报警 Correlation alarm				
	D01AlarmRel evance11	32-47 位 0: 否 NO 1: 是 YES				
D01AlarmRel evance12	关联报警 Correlation alarm					
		48-63 位 0: 否 NO 1: 是 YES				
		关联报警 Correlation alarm				
		64-79 位				

		<p>0: 否 NO 1: 是 YES</p> <p>关联报警 Correlation alarm</p> <p>80-95 位</p> <p>0: 否 NO 1: 是 YES</p> <p>关联报警 Correlation alarm</p> <p>96-111 位</p> <p>0: 否 NO 1: 是 YES</p> <p>关联报警 Correlation alarm</p> <p>112-127 位</p> <p>0: 否 NO 1: 是 YES</p> <p>关联报警 Correlation alarm</p> <p>128-143 位</p> <p>0: 否 NO 1: 是 YES</p> <p>关联报警 Correlation alarm</p> <p>144-159 位</p> <p>0: 否 NO 1: 是 YES</p> <p>关联报警 Correlation alarm</p> <p>160-175 位</p> <p>0: 否 NO 1: 是 YES</p> <p>关联报警 Correlation alarm</p> <p>176-191 位</p> <p>0: 否 NO 1: 是 YES</p>				
0x1110	D02Set	<p>D02 参数设置</p> <p>Parameter setting</p>	R/W	16	Uint16	<p>同 D01 参数设置</p> <p>Same D01 parameter setting</p>
0x1120	D03Set	<p>D03 参数设置</p> <p>Parameter setting</p>	R/W	16	Uint16	<p>同 D01 参数设置</p> <p>Same D01 parameter setting</p>
0x1130	D04Set	<p>D04 参数设置</p> <p>Parameter setting</p>	R/W	16	Uint16	<p>同 D01 参数设置</p> <p>Same D01 parameter setting</p>
报警 1 段参数						

Alarm 1 segment parameters						
0x1200	Alarm_Ia Alarm_Ia_HV value Alarm_Ia_LV value Alarm_Ia_Ba nd Alarm_Ia_De lay Alarm_Ia_Re corvyDelay	<p>A 相电流报警 A phase current alarm</p> <p>高字节 high byte 0: 值为 0 时报警禁止, alarm disabled when the value is 0 1: 值为 1 时报警使能 alarm abled when the value is 1</p> <p>低字节 low byte 0: 报警关闭, 1: 报警打开 when the value is 0: alarm off 1: Alarm on</p> <p>A 相电流高报警值 A phase current high alarm value</p> <p>A 相电流低报警值 A phase current low alarm value</p> <p>A 相电流报警不动作带 (回滞量) A phase current alarm does not operate with (hysteresis).</p> <p>A 相电流报警延时 Phase A current alarm delay</p> <p>A 相电流报警恢复延时 Phase A current alarm recovery delay</p>	R/W	6	Uint16	<p>报警高字节: Alarm high byte: 0: 0 时报警禁止 Alarm is prohibited at 0 1: 0 时报警使能 Alarm enabled at 1</p> <p>报警低字节: Alarm low byte: 0: 报警关闭 Alarm off 1: 报警打开 Alarm on</p> <p>报警值 Alarm value: -120.0%~+120.0%</p> <p>不动作带 Inactive band: 0.0%~20.0%</p> <p>延时 Delay: 1~9999</p> <p>恢复延时 Recovery delay: 1~9999</p>
0x1206	Alarm_Ib	<p>B 相电流报警 B-phase current alarm</p>	R/W	6	Uint16	同 A 相电流报警 Same as phase A current alarm
0x120C	Alarm_Ic	<p>C 相电流报警 C-phase current alarm</p>	R/W	6	Uint16	同 A 相电流报警 Same as phase A current alarm
0x1212	Alarm_Ix	<p>任意相电流报警 (不包括 N 线) Any phase current alarm (excluding N-line).</p>	R/W	6	Uint16	同 A 相电流报警 Same as phase A current alarm

0x1218	Alarm_In	N 相电流报警 N phase current alarm	R/W	6	Uint16	同 A 相电流报警 Same as phase A current alarm
0x121E	Alarm_Ua	A 相电压报警 A-phase voltage alarm	R/W	6	Uint16	同 A 相电流报警 Same as phase A current alarm
0x1224	Alarm_Ub	B 相电压报警 B-phase voltage alarm	R/W	6	Uint16	同 A 相电流报警 Same as phase A current alarm
0x122A	Alarm_Uc	C 相电压报警 C-phase voltage alarm	R/W	6	Uint16	同 A 相电流报警 Same as phase A current alarm
0x1230	Alarm_Ux	任意相电压报警 Any phase voltage alarm	R/W	6	Uint16	同 A 相电流报警 Same as phase A current alarm
0x1236	Alarm_Uab	AB 线电压报警 AB line voltage alarm	R/W	6	Uint16	同 A 相电流报警 Same as phase A current alarm
0x123C	Alarm_Ubc	BC 线电压报警 BC line voltage alarm	R/W	6	Uint16	同 A 相电流报警 Same as phase A current alarm
0x1242	Alarm_Uca	CA 线电压报警 CA line voltage alarm	R/W	6	Uint16	同 A 相电流报警 Same as phase A current alarm
0x1248	Alarm_Uxx	任意线电压报警 Any line voltage alarm	R/W	6	Uint16	同 A 相电流报警 Same as phase A current alarm
0x124E	Alarm_Pa	A 相有功功率报警 A phase active power alarm	R/W	6	Uint16	同 A 相电流报警 Same as phase A current alarm
0x1254	Alarm_Pb	B 相有功功率报警 B phase active power alarm	R/W	6	Uint16	同 A 相电流报警 Same as phase A current alarm
0x125A	Alarm_Pc	C 相有功功率报警 C phase active power alarm	R/W	6	Uint16	同 A 相电流报警 Same as phase A current alarm
0x1260	Alarm_Ps	总有功功率报警 Total active power alarm	R/W	6	Uint16	同 A 相电流报警 Same as phase A current alarm
0x1266	Alarm_Qa	A 相无功功率报警	R/W	6	Uint16	同 A 相电流报警

		A phase reactive power alarm				Same as phase A current alarm
0x126C	Alarm_Qb	B 相无功功率报警 B-phase reactive power alarm	R/W	6	Uint16	同 A 相电流报警 Same as phase A current alarm
0x1272	Alarm_Qc	C 相无功功率报警 C phase reactive power alarm	R/W	6	Uint16	同 A 相电流报警 Same as phase A current alarm
0x1278	Alarm_Qs	总无功功率报警 Total reactive power alarm	R/W	6	Uint16	同 A 相电流报警 Same as phase A current alarm
0x127E	Alarm_Sa	A 相视在功率报警 A-phase apparent power alarm	R/W	6	Uint16	同 A 相电流报警 Same as phase A current alarm
0x1284	Alarm_Sb	B 相视在功率报警 B-phase apparent power alarm	R/W	6	Uint16	同 A 相电流报警 Same as phase A current alarm
0x128A	Alarm_Sc	C 相视在功率报警 C-phase apparent power alarm	R/W	6	Uint16	同 A 相电流报警 Same as phase A current alarm
0x1290	Alarm_Ss	总视在功率高报警 Total apparent power high alarm	R/W	6	Uint16	同 A 相电流报警 Same as phase A current alarm
0x1296	Alarm_PFa	A 相功率因数报警 A-phase power factor alarm	R/W	6	Uint16	同 A 相电流报警 Same as phase A current alarm
0x129C	Alarm_PFb	B 相功率因数报警 B-phase power factor alarm	R/W	6	Uint16	同 A 相电流报警 Same as phase A current alarm
0x12A2	Alarm_PFc	C 相功率因数报警 C-phase power factor alarm	R/W	6	Uint16	同 A 相电流报警 Same as phase A current alarm
0x12A8	Alarm_PF	总功率因数报警 Total power factor alarm	R/W	6	Uint16	同 A 相电流报警 Same as phase A current alarm
0x12AE	Alarm_F	频率报警 Frequency alarm	R/W	6	Uint16	同 A 相电流报警 Same as phase A current alarm
0x12B4	Alarm_Uunbalance	电压不平衡度报警 Voltage imbalance alarm	R/W	6	Uint16	同 A 相电流报警 Same as phase A current alarm

0x12BA	Alarm_Iunbalance	电流不平衡度报警 Current imbalance alarm	R/W	6	Uint16	同 A 相电流报警 Same as phase A current alarm
0x12C0	Alarm_THDIaP	A 相电流总谐波含有率报警 A-phase current total harmonic content alarm	R/W	6	Uint16	同 A 相电流报警 Same as phase A current alarm
0x12C6	Alarm_THDIbP	B 相电流总谐波含有率报警 B-phase current total harmonic content alarm	R/W	6	Uint16	同 A 相电流报警 Same as phase A current alarm
0x12CC	Alarm_THDIcP	C 相电流总谐波含有率报警 C-phase current total harmonic content alarm	R/W	6	Uint16	同 A 相电流报警 Same as phase A current alarm
0x12D2	Alarm_THDUaP	A 相电压总谐波含有率报警 A-phase voltage total harmonic content alarm	R/W	6	Uint16	同 A 相电流报警 Same as phase A current alarm
0x12D8	Alarm_THDUbP	B 相电压总谐波含有率报警 B-phase voltage total harmonic content alarm	R/W	6	Uint16	同 A 相电流报警 Same as phase A current alarm
0x12DE	Alarm_THDUcP	C 相电压总谐波含有率报警 C-phase voltage total harmonic content alarm	R/W	6	Uint16	同 A 相电流报警 Same as phase A current alarm
0x12E4	Alarm_THDIaPO	A 相电流总偶次谐波含有率报警 A-phase current total even harmonic content rate alarm	R/W	6	Uint16	同 A 相电流报警 Same as phase A current alarm
0x12EA	Alarm_THDIbPO	B 相电流总偶次谐波含有率报警 B-phase current total even harmonic content rate alarm	R/W	6	Uint16	同 A 相电流报警 Same as phase A current alarm
0x12F0	Alarm_THDIcPO	C 相电流总偶次谐波含有率报警 C-phase current total even harmonic	R/W	6	Uint16	同 A 相电流报警 Same as phase A current alarm

		content rate alarm				
0x12F6	Alarm_THDUa PO	A 相电压总偶次谐波含有率报警 A-phase voltage total even harmonic content rate alarm	R/W	6	Uint16	同 A 相电流报警 Same as phase A current alarm
0x12FC	Alarm_THDUb PO	B 相电压总偶次谐波含有率报警 B-phase voltage total even harmonic content rate alarm	R/W	6	Uint16	同 A 相电流报警 Same as phase A current alarm
0x1302	Alarm_THDUc PO	C 相电压总偶次谐波含有率报警 C-phase voltage total even harmonic content rate alarm	R/W	6	Uint16	同 A 相电流报警 Same as phase A current alarm
0x1308	Alarm_THDIa PE	A 相电流总奇次谐波含有率报警 A-phase current total odd harmonic content rate alarm	R/W	6	Uint16	同 A 相电流报警 Same as phase A current alarm
0x130E	Alarm_THDIb PE	B 相电流总奇次谐波含有率报警 B-phase current total odd harmonic content rate alarm	R/W	6	Uint16	同 A 相电流报警 Same as phase A current alarm
0x1314	Alarm_THDIc PE	C 相电流总奇次谐波含有率报警 C-phase current total odd harmonic content rate alarm	R/W	6	Uint16	同 A 相电流报警 Same as phase A current alarm
0x131A	Alarm_THDUa PE	A 相电压总奇次谐波含有率报警 A-phase voltage total odd harmonic content rate alarm	R/W	6	Uint16	同 A 相电流报警 Same as phase A current alarm
0x1320	Alarm_THDUb PE	B 相电压总奇次谐波含有率报警 B-phase voltage total odd harmonic content rate alarm	R/W	6	Uint16	同 A 相电流报警 Same as phase A current alarm
0x1326	Alarm_THDUc PE	C 相电压总奇次谐波含有率报警 C-phase voltage total odd harmonic content rate alarm	R/W	6	Uint16	同 A 相电流报警 Same as phase A current alarm

0x132C	Alarm_Iadem and	A 相电流需量报警 A-phase current demand alarm	R/W	6	Uint16	同 A 相电流报警 Same as phase A current alarm
0x1332	Alarm_Ibdem and	B 相电流需量报警 B-phase current demand alarm	R/W	6	Uint16	同 A 相电流报警 Same as phase A current alarm
0x1338	Alarm_Icdem and	C 相电流需量报警 C-phase current demand alarm	R/W	6	Uint16	同 A 相电流报警 Same as phase A current alarm
0x133E	Alarm_PPdem and	总正向有功需量报警 Total positive active demand alarm	R/W	6	Uint16	同 A 相电流报警 Same as phase A current alarm
0x1344	Alarm_PNdem and	总反向有功需量报警 Total reverse active demand alarm	R/W	6	Uint16	同 A 相电流报警 Same as phase A current alarm
0x134A	Alarm_QPdem and	总正向无功需量报警 Total forward reactive power demand alarm	R/W	6	Uint16	同 A 相电流报警 Same as phase A current alarm
0x1350	Alarm_QNdem and	总反向无功需量报警 Total reverse reactive power demand alarm	R/W	6	Uint16	同 A 相电流报警 Same as phase A current alarm
0x1356	Alarm_Sdema nd	总视在功率需量报警 Total apparent power demand alarm	R/W	6	Uint16	同 A 相电流报警 Same as phase A current alarm
0x135C	Alarm_DI1	DI1 报警 DI1 alarm	R/W	6	Uint16	报警高字节： Alarm high byte: 0: 0 时报警禁止 Alarm is prohibited at 0 1: 0 时报警使能 Alarm enabled at 1 报警低字节： Alarm low byte: 0: 报警关闭 Alarm off 1: 报警打开 Alarm on

						报警值 Alarm value: -120.0%~+120.0% 不动作带 Inactive band: 0.0%~20.0% 延时 Delay: 1~9999 恢复延时 Recovery delay: 1~9999
0x1362	Alarm_DI2	DI2 报警 DI2 alarm	R/W	6	Uint16	同 DI1 报警 Same as DI1 alarm
0x1368	Alarm_DI3	DI3 报警 DI3 alarm	R/W	6	Uint16	同 DI1 报警 Same as DI1 alarm
0x136E	Alarm_DI4	DI4 报警 DI4 alarm	R/W	6	Uint16	同 DI1 报警 Same as DI1 alarm
0x1374	Alarm_DI5	DI5 报警 DI5 alarm	R/W	6	Uint16	同 DI1 报警 Same as DI1 alarm
0x137A	Alarm_DI6	DI6 报警 DI6 alarm	R/W	6	Uint16	同 DI1 报警 Same as DI1 alarm
0x1380	Alarm_DI7	DI7 报警 DI7 alarm	R/W	6	Uint16	同 DI1 报警 Same as DI1 alarm
0x1386	Alarm_DI8	DI8 报警 DI8 alarm	R/W	6	Uint16	同 DI1 报警 Same as DI1 alarm
0x138C	Alarm_DI9	DI9 报警 DI9 alarm	R/W	6	Uint16	同 DI1 报警 Same as DI1 alarm
0x1392	Alarm_DI10	DI10 报警 DI10 alarm	R/W	6	Uint16	同 DI1 报警 Same as DI1 alarm
0x1398	Alarm_DI11	DI11 报警 DI11 alarm	R/W	6	Uint16	同 DI1 报警 Same as DI1 alarm

0x139E	Alarm_DI12	DI12 报警 DI12 alarm	R/W	6	Uint16	同 DI1 报警 Same as DI1 alarm
0x13A4	Alarm_DI13	DI13 报警 DI13 alarm	R/W	6	Uint16	同 DI1 报警 Same as DI1 alarm
0x13AA	Alarm_DI14	DI14 报警 DI14 alarm	R/W	6	Uint16	同 DI1 报警 Same as DI1 alarm
0x13B0	Alarm_DI15	DI15 报警 DI15 alarm	R/W	6	Uint16	同 DI1 报警 Same as DI1 alarm
0x13B6	Alarm_DI16	DI16 报警 DI16 alarm	R/W	6	Uint16	同 DI1 报警 Same as DI1 alarm
报警 2 段参数（报警参数内容同报警 1 段参数） Alarm 2-stage parameter (alarm parameter content is the same as alarm 1-stage parameter)						
0x1700	Alarm_Ia Alarm_Ia_HV alue Alarm_Ia_LV alue Alarm_Ia_Ba nd Alarm_Ia_De lay Alarm_Ia_Re corvyDelay	A 相电流报警 A-phase current alarm 高字节 High byte 0 时报警静止，1 时报警使能 0when the alarm is still, and 1 when the alarm is enabled 低字节 Low byte 0:报警关闭，1: 报警打开 0: alarm off, 1: alarm on A 相电流高报警值 A-phase current high alarm value A 相电流低报警值 A-phase current low alarm value A 相电流报警不动作带 A-phase current alarm no action belt A 相电流报警延时 A-phase current alarm delay	R/W	6	Uint16	

		A 相电流报警恢复延时 A-phase current alarm recovery delay				
0x1706	Alarm_Ib	B 相电流报警 B-phase current alarm	R/W	6	Uint16	
0x170C	Alarm_Ic	C 相电流报警 C-phase current alarm	R/W	6	Uint16	
0x1712	Alarm_Ix	任意相电流报警（不包括 N 线） Any phase current alarm (excluding N-line).	R/W	6	Uint16	
0x1718	Alarm_In	N 相电流报警 N phase current alarm	R/W	6	Uint16	
0x171E	Alarm_Ua	A 相电压报警 A-phase voltage alarm	R/W	6	Uint16	
0x1724	Alarm_Ub	B 相电压报警 B-phase voltage alarm	R/W	6	Uint16	
0x172A	Alarm_Uc	C 相电压报警 C-phase voltage alarm	R/W	6	Uint16	
0x1730	Alarm_Ux	任意相电压报警 Any phase voltage alarm	R/W	6	Uint16	
0x1736	Alarm_Uab	AB 线电压报警 AB line voltage alarm	R/W	6	Uint16	
0x173C	Alarm_Ubc	BC 线电压报警 BC line voltage alarm	R/W	6	Uint16	
0x1742	Alarm_Uca	CA 线电压报警 CA line voltage alarm	R/W	6	Uint16	
0x1748	Alarm_Uxx	任意线电压报警 Any line voltage alarm	R/W	6	Uint16	

0x174E	Alarm_Pa	A 相有功功率报警 A phase active power alarm	R/W	6	Uint16	
0x1754	Alarm_Pb	B 相有功功率报警 B-phase active power alarm	R/W	6	Uint16	
0x175A	Alarm_Pc	C 相有功功率报警 C-phase active power alarm	R/W	6	Uint16	
0x1760	Alarm_Ps	总有功功率报警 Total active power alarm	R/W	6	Uint16	
0x1766	Alarm_Qa	A 相无功功率报警 A phase reactive power alarm	R/W	6	Uint16	
0x176C	Alarm_Qb	B 相无功功率报警 B-phase reactive power alarm	R/W	6	Uint16	
0x1772	Alarm_Qc	C 相无功功率报警 C phase reactive power alarm	R/W	6	Uint16	
0x1778	Alarm_Qs	总无功功率报警 Total reactive power alarm	R/W	6	Uint16	
0x177E	Alarm_Sa	A 相视在功率报警 A-phase apparent power alarm	R/W	6	Uint16	
0x1784	Alarm_Sb	B 相视在功率报警 B-phase apparent power alarm	R/W	6	Uint16	
0x178A	Alarm_Sc	C 相视在功率报警 C-phase apparent power alarm	R/W	6	Uint16	
0x1790	Alarm_Ss	总视在功率高报警 Total apparent power high alarm	R/W	6	Uint16	
0x1796	Alarm_PFa	A 相功率因数报警 A-phase power factor alarm	R/W	6	Uint16	

0x179C	Alarm_PFb	B 相功率因数报警 B-phase power factor alarm	R/W	6	Uint16	
0x17A2	Alarm_PFc	C 相功率因数报警 C-phase power factor alarm	R/W	6	Uint16	
0x17A8	Alarm_PF	总功率因数报警 Total power factor alarm	R/W	6	Uint16	
0x17AE	Alarm_F	频率报警 Frequency alarm	R/W	6	Uint16	
0x17B4	Alarm_Uunbalance	电压不平衡度报警 Voltage imbalance alarm	R/W	6	Uint16	
0x17BA	Alarm_Iunbalance	电流不平衡度报警 Current imbalance alarm	R/W	6	Uint16	
0x17C0	Alarm_THDIaP	A 相电流总谐波含有率报警 A-phase current total harmonic content alarm	R/W	6	Uint16	
0x17C6	Alarm_THDIbP	B 相电流总谐波含有率报警 B-phase current total harmonic content alarm	R/W	6	Uint16	
0x17CC	Alarm_THDIcP	C 相电流总谐波含有率报警 C-phase current total harmonic content alarm	R/W	6	Uint16	
0x17D2	Alarm_THDUaP	A 相电压总谐波含有率报警 A-phase voltage total harmonic content alarm	R/W	6	Uint16	
0x17D8	Alarm_THDUbP	B 相电压总谐波含有率报警 B-phase voltage total harmonic content alarm	R/W	6	Uint16	
0x17DE	Alarm_THDUcP	C 相电压总谐波含有率报警	R/W	6	Uint16	

	P	C-phase voltage total harmonic content alarm				
0x17E4	Alarm_THDIa PO	A 相电流总偶次谐波含有率报警 A-phase current total even harmonic content rate alarm	R/W	6	Uint16	
0x17EA	Alarm_THDIb PO	B 相电流总偶次谐波含有率报警 B-phase current total even harmonic content rate alarm	R/W	6	Uint16	
0x17F0	Alarm_THDIc PO	C 相电流总偶次谐波含有率报警 C-phase current total even harmonic content rate alarm	R/W	6	Uint16	
0x17F6	Alarm_THDUa PO	A 相电压总偶次谐波含有率报警 A-phase voltage total even harmonic content rate alarm	R/W	6	Uint16	
0x17FC	Alarm_THDUb PO	B 相电压总偶次谐波含有率报警 B-phase voltage total even harmonic content rate alarm	R/W	6	Uint16	
0x1802	Alarm_THDUc PO	C 相电压总偶次谐波含有率报警 C-phase voltage total even harmonic content rate alarm	R/W	6	Uint16	
0x1808	Alarm_THDIa PE	A 相电流总奇次谐波含有率报警 A-phase current total odd harmonic content rate alarm	R/W	6	Uint16	
0x180E	Alarm_THDIb PE	B 相电流总奇次谐波含有率报警 B-phase current total odd harmonic content rate alarm	R/W	6	Uint16	
0x1814	Alarm_THDIc PE	C 相电流总奇次谐波含有率报警 C-phase current total odd harmonic content rate alarm	R/W	6	Uint16	

0x181A	Alarm_THDUa PE	A 相电压总奇次谐波含有率报警 A-phase voltage total odd harmonic content rate alarm	R/W	6	Uint16	
0x1820	Alarm_THDUb PE	B 相电压总奇次谐波含有率报警 B-phase voltage total odd harmonic content rate alarm	R/W	6	Uint16	
0x1826	Alarm_THDUc PE	C 相电压总奇次谐波含有率报警 C-phase voltage total odd harmonic content rate alarm	R/W	6	Uint16	
0x182C	Alarm_Iadem and	A 相电流需量报警 A-phase current demand alarm	R/W	6	Uint16	
0x1832	Alarm_Ibdem and	B 相电流需量报警 B-phase current demand alarm	R/W	6	Uint16	
0x1838	Alarm_Icdem and	C 相电流需量报警 C-phase current demand alarm	R/W	6	Uint16	
0x183E	Alarm_PPdem and	总正向有功需量报警 Total positive active demand alarm	R/W	6	Uint16	
0x1844	Alarm_PNdem and	总反向有功需量报警 Total reverse active demand alarm	R/W	6	Uint16	
0x184A	Alarm_QPdem and	总正向无功需量报警 Total forward reactive power demand alarm	R/W	6	Uint16	
0x1850	Alarm_QNdem and	总反向无功需量报警 Total reverse reactive power demand alarm	R/W	6	Uint16	
0x1856	Alarm_Sdema nd	总视在功率需量报警 Total apparent power demand alarm	R/W	6	Uint16	
0x185C	Alarm_DI1	DI1 报警	R/W	6	Uint16	

		DI1 报警 DI1 alarm				
0x1862	Alarm_DI2	DI2 报警 DI2 alarm	R/W	6	Uint16	
0x1868	Alarm_DI3	DI3 报警 DI3 alarm	R/W	6	Uint16	
0x186E	Alarm_DI4	DI4 报警 DI4 alarm	R/W	6	Uint16	
0x1874	Alarm_DI5	DI5 报警 DI5 alarm	R/W	6	Uint16	
0x187A	Alarm_DI6	DI6 报警 DI6 alarm	R/W	6	Uint16	
0x1880	Alarm_DI7	DI7 报警 DI7 alarm	R/W	6	Uint16	
0x1886	Alarm_DI8	DI8 报警 DI8 alarm	R/W	6	Uint16	
0x188C	Alarm_DI9	DI9 报警 DI9 alarm	R/W	6	Uint16	
0x1892	Alarm_DI10	DI10 报警 DI10 alarm	R/W	6	Uint16	
0x1898	Alarm_DI11	DI11 报警 DI11 alarm	R/W	6	Uint16	
0x189E	Alarm_DI12	DI12 报警 DI12 alarm	R/W	6	Uint16	
0x18A4	Alarm_DI13	DI13 报警 DI13 alarm	R/W	6	Uint16	
0x18AA	Alarm_DI14	DI14 报警 DI14 alarm	R/W	6	Uint16	

0x18B0	Alarm_DI15	DI15 报警 DI15 alarm	R/W	6	Uint16	
0x18B6	Alarm_DI16	DI16 报警 DI16 alarm	R/W	6	Uint16	

仪表基本电参量信息区（功能码 03H 、04H）

Basic electrical parameter information area of the instrument (function codes 03H, 04H)

偏移地址 Address	名称 Name	解释 Explanation	R/W	字长 word	类型 type	备注 note
0x2000	UA	A 相电压 Phase A voltage	R	2	float	V
0x2002	UB	B 相电压 Phase B voltage	R	2	float	V
0x2004	UC	C 相电压 Phase C voltage	R	2	float	V
0x2006	UAB	AB 线电压 AB line voltage	R	2	float	V
0x2008	UBC	BC 线电压 BC line voltage	R	2	float	V
0x200a	UCA	CA 线电压 CA line voltage	R	2	float	V
0x200c	IA	A 相电流 Phase A current	R	2	float	A
0x200e	IB	B 相电流 B phase current	R	2	float	A
0x2010	IC	C 相电流 C phase current	R	2	float	A
0x2012	IN	N 线电流 N line current	R	2	float	A

0x2014	PA	A 相有功功率 Phase A active power	R	2	float	kW
0x2016	PB	B 相有功功率 Phase B active power	R	2	float	kW
0x2018	PC	C 相有功功率 Phase C active power	R	2	float	kW
0x201a	PT	总有功功率 Total active power	R	2	float	kW
0x201c	QA	A 相无功功率 Phase A reactive power	R	2	float	Kvar
0x201e	QB	B 相无功功率 Phase B reactive power	R	2	float	Kvar
0x2020	QC	C 相无功功率 Phase C reactive power	R	2	float	Kvar
0x2022	QT	总无功功率 Total reactive power	R	2	float	Kvar
0x2024	SA	A 相视在功率 A phase apparent power	R	2	float	KVA
0x2026	SB	B 相视在功率 B phase apparent power	R	2	float	KVA
0x2028	SC	C 相视在功率 C phase apparent power	R	2	float	KVA
0x202a	ST	总视在功率 Total apparent power	R	2	float	KVA
0x202c	PFA	A 相功率因数 Phase A power factor	R	2	float	
0x202e	PFB	B 相功率因数	R	2	float	

		Phase B power factor				
0x2030	PFC	C 相功率因数 Phase C power factor	R	2	float	
0x2032	PF	总功率因数 Total power factor	R	2	float	
0x2034	F	频率 Frequency	R	2	float	Hz
0x2036	UNAvg	相电压平均值 Average phase voltage	R	2	float	V
0x2038	ULAvg	线电压平均值 Average line voltage	R	2	float	V
0x203a	IAvg	电流平均值 Average current value	R	2	float	A
0x203c	Unbalance	电压不平衡度 Voltage imbalance degree	R	2	float	%
0x203e	Iunbalance	电流不平衡度 Current imbalance degree	R	2	float	%
0x2040	Uresidual	零序电压 Zero sequence voltage	R	2	float	V
0x2042	Iresidual	零序电流 Zero sequence current	R	2	float	A
0x2044	APangle	A 功率角度 A Power Angle	R	2	float	°
0x2046	BPangle	B 功率角度 B Power Angle	R	2	float	°
0x2048	CPangle	C 功率角度 C Power Angle	R	2	float	°

0x204a	AUangle	A 电压角度 A Voltage Angle	R	2	float	°
0x204c	BUangle	B 电压角度 B Voltage Angle	R	2	float	°
0x204e	CUangle	C 电压角度 C Voltage Angle	R	2	float	°
0x2050	AIangle	A 电流角度 A Current Angle	R	2	float	°
0x2052	BIangle	B 电流角度 B Current Angle	R	2	float	°
0x2054	CIangle	C 电流角度 C Current Angle	R	2	float	°

快速响应寄存器地址						
1. 快速寄存器 (响应时间<=100ms)						
1. Fast register (response rate <=100ms)						
偏移地址	名称	解释	R/W	字长	类型	备注
Address	Name	Explanation		word	type	note
0x2100	UA	A 相电压 Phase A voltage	R	2	float	V
0x2102	UB	B 相电压 Phase B voltage	R	2	float	V
0x2104	UC	C 相电压 Phase C voltage	R	2	float	V
0x2106	UAB	AB 线电压 AB line voltage	R	2	float	V
0x2108	UBC	BC 线电压 BC line voltage	R	2	float	V

0x210a	UCA	CA 线电压 CA line voltage	R	2	float	V
0x210c	IA	A 相电流 Phase A current	R	2	float	A
0x210e	IB	B 相电流 B phase current	R	2	float	A
0x2110	IC	C 相电流 C phase current	R	2	float	A
0x2112	IN	N 线电流 N line current	R	2	float	A
0x2114	PA	A 相有功功率 Phase A active power	R	2	float	kW
0x2116	PB	B 相有功功率 Phase B active power	R	2	float	kW
0x2118	PC	C 相有功功率 Phase C active power	R	2	float	kW
0x211a	PT	总有功功率 Total active power	R	2	float	kW
0x211c	QA	A 相无功功率 Phase A reactive power	R	2	float	Kvar
0x211e	QB	B 相无功功率 Phase B reactive power	R	2	float	Kvar
0x2120	QC	C 相无功功率 Phase C reactive power	R	2	float	Kvar
0x2122	QT	总无功功率 Total reactive power	R	2	float	Kvar
0x2124	SA	A 相视在功率	R	2	float	KVA

		A phase apparent power				
0x2126	SB	B 相视在功率 B phase apparent power	R	2	float	KVA
0x2128	SC	C 相视在功率 C phase apparent power	R	2	float	KVA
0x212a	ST	总视在功率 Total apparent power	R	2	float	KVA
0x212c	PFA	A 相功率因数 Phase A power factor	R	2	float	
0x212e	PFB	B 相功率因数 Phase B power factor	R	2	float	
0x2130	PFC	C 相功率因数 Phase C power factor	R	2	float	
0x2132	PF	总功率因数 Total power factor	R	2	float	
0x2134	F	频率 Frequency	R	2	float	Hz
0x2136	UNAvg	相电压平均值 Average phase voltage	R	2	float	V
0x2138	ULAvg	线电压平均值 Average line voltage	R	2	float	V
0x213a	IAvg	电流平均值 Average current value	R	2	float	A
0x213c	Unbalance	电压不平衡度 Voltage imbalance degree	R	2	float	%
0x213e	Iunbalance	电流不平衡度 Current imbalance degree	R	2	float	%

0x2140	Uresidual	零序电压 Zero sequence voltage	R	2	float	V
0x2142	Iresidual	零序电流 Zero sequence current	R	2	float	A
0x2144	APangle	A 功率角度 A Power Angle	R	2	float	°
0x2146	BPangle	B 功率角度 B Power Angle	R	2	float	°
0x2148	CPangle	C 功率角度 C Power Angle	R	2	float	°
0x214a	AUangle	A 电压角度 A Voltage Angle	R	2	float	°
0x214c	BUangle	B 电压角度 B Voltage Angle	R	2	float	°
0x214e	CUangle	C 电压角度 C Voltage Angle	R	2	float	°
0x2150	AIangle	A 电流角度 A Current Angle	R	2	float	°
0x2152	BIangle	B 电流角度 B Current Angle	R	2	float	°
0x2154	CIangle	C 电流角度 C Current Angle	R	2	float	°

0xE000	ZoneNum1, ZoneMonth1, ZoneDay1 ZoneNum2, ZoneMonth2, ZoneDay2	第一时区时段表号 Time period table number of the first time zone: 第一时区开始月 The beginning month of the first time zone,	R/W	21	Uint16	时段表号 Time period table number: 第 1 时段 Period 1, 第 2 时段 Period 2, 第 3 时段 Period 3,
--------	--	--	-----	----	--------	---

<p>neDay2 ZoneNum3, ZoneMonth3, ZoneDay3 neDay3 ZoneNum4, ZoneMonth4, ZoneDay4 neDay4 ZoneNum5, ZoneMonth5, ZoneDay5 neDay5 ZoneNum6, ZoneMonth6, ZoneDay6 neDay6 ZoneNum7, ZoneMonth7, ZoneDay7 neDay7 ZoneNum8, ZoneMonth8, ZoneDay8 neDay8 ZoneNum9, ZoneMonth9, ZoneDay9 ZoneNum10, ZoneMonth10, ZoneDay10 ZoneNum11, ZoneMonth11, ZoneDay11 ZoneNum12, ZoneMonth12,</p>	<p>第一时区日 First Time Zone day 第二时区时段表号 Second time zone period table number: 第二时区开始月 The starting month of the second time zone, 第二时区日 Second Time Zone Day 第三时区时段表号 Time period table number of the third time zone: 第三时区开始月 The beginning month of the third time zone, 第三时区日 The third Time zone day 第四时区时段表号 Fourth time zone period table number: 第四时区开始月 The starting month of the fourth time zone, 第四时区日 The Fourth Time Zone day 第五时区时段表号 Time period table number of the fifth time zone: 第五时区开始月 The starting month of the fifth time zone, 第五时区日 The Fifth Time Zone day 第六时区时段表号 Time period table number of the sixth time zone: 第六时区开始月 The month when</p>				<p>第 4 时段 Period 4, 第 5 时段 Period 5, 第 6 时段 Period 6, 第 7 时段 Period 7, 第 8 时段 Period 8, 开始月 Starting month: 1-12 January - December 开始日 Start date: 1-31</p>
--	--	--	--	--	---

	<p>ZoneDay12</p> <p>ZoneNum13, ZoneMonth13,</p> <p>ZoneDay13</p> <p>ZoneNum14, ZoneMonth14,</p> <p>ZoneDay14</p>	<p>the sixth time zone begins,</p> <p>第六时区日 The sixth Time Zone day</p> <p>第七时区时段表号 Time period table number of time Zone 7:</p> <p>第七时区开始月 The month when the seventh time zone begins,</p> <p>第七时区日 Time Zone seventh Day</p> <p>第八时区时段表号 Time period table number of the eighth time zone:</p> <p>第八时区开始月 The starting month of the eighth time zone,</p> <p>第八时区日 The eighth Time Zone Day</p> <p>第九时区时段表号 Time period table number of the ninth time zone:</p> <p>第九时区开始月 The starting month of the ninth time zone,</p> <p>第九时区日 The ninth Time Zone Day</p> <p>第十时区时段表号 Time period table number of the tenth time zone:</p> <p>第十时区开始月 The starting month of the tenth time zone,</p> <p>第十时区日 The tenth Time Zone Day</p>				
--	--	--	--	--	--	--

	<p>第十一时区时段表号 Time period table number of the eleventh time zone:</p> <p>第十一时区开始月 The starting month of the eleventh time zone,</p> <p>第十一时区日 The eleventh Time Zone Day</p> <p>第十二时区时段表号 Time period table number of the twelfth time zone:</p> <p>第十二时区开始月 The starting month of the twelfth time zone,</p> <p>第十二时区日 The twelfth Time Zone Day</p> <p>第十三时区时段表号 Time period table number of the thirteenth time zone:</p> <p>第十三时区开始月 The starting month of the thirteenth time zone,</p> <p>第十三时区日 The thirteenth Time Zone Day</p> <p>第十四时区时段表号 Time period table number of the fourteenth time zone:</p> <p>第十四时区开始月 The starting month of the fourteenth time zone,</p> <p>第十四时区日 The fourteenth</p>				
--	--	--	--	--	--

		Time Zone Day				
0xE02A	Table1 Rt1~Rt14	<p>第一套时段表，</p> <p>每个时段占用三个字节，</p> <p>分别为费率，开始时，开始分</p> <p>The first set of time period tables</p> <p>Each period occupies three bytes.</p> <p>They are respectively the rates. At the beginning, the distribution starts</p>	R/W	21	Uin16	<p>费率 Rate: 0</p> <p>1尖 tip, 2峰 peaks</p> <p>3平 levels, 4谷 grains</p> <p>开始时 At the beginnin:0-23</p> <p>开始分 Starting score: 1-59</p>
0xE03F	Table2 Rt1~Rt14	<p>第二套时段表，</p> <p>每个时段占用三个字节，</p> <p>分别为费率，开始时，开始分</p> <p>The second set of time period tables</p> <p>Each period occupies three bytes.</p> <p>They are respectively the rates. At the beginning, the distribution starts</p>	R/W	21	Uin16	<p>同第一套时段表</p> <p>The same as the first set of time schedule</p>
0xE054	Table3 Rt1~Rt14	<p>第三套时段表，</p> <p>每个时段占用三个字节，</p> <p>分别为费率，开始时，开始分</p> <p>The third set of time period tables</p> <p>Each period occupies three bytes.</p> <p>They are respectively the rates. At the beginning, the</p>	R/W	21	Uin16	<p>同第一套时段表</p> <p>The same as the first set of time schedule</p>

		distribution starts				
0xE069	Table4 Rt1~Rt14	<p>第四套时段表， 每个时段占用三个字节， 分别为费率，开始时，开始分</p> <p>The fourth set of time period tables</p> <p>Each period occupies three bytes.</p> <p>They are respectively the rates. At the beginning, the distribution starts</p>	R/W	21	Uint16	<p>同第一套时段表</p> <p>The same as the first set of time schedule</p>
0xE07E	Table5 Rt1~Rt14	<p>第五套时段表， 每个时段占用三个字节， 分别为费率，开始时，开始分</p> <p>The Fifth set of time period tables</p> <p>Each period occupies three bytes.</p> <p>They are respectively the rates. At the beginning, the distribution starts</p>	R/W	21	Uint16	<p>同第一套时段表</p> <p>The same as the first set of time schedule</p>
0xE093	Table6 Rt1~Rt14	<p>第六套时段表， 每个时段占用三个字节， 分别为费率，开始时，开始分</p> <p>The sixth set of time period tables</p> <p>Each period occupies three bytes.</p> <p>They are respectively the rates. At the beginning, the</p>	R/W	21	Uint16	<p>同第一套时段表</p> <p>The same as the first set of time schedule</p>

		distribution starts				
0xE0A8	Table7 Rt1~Rt14	第七套时段表, 每个时段占用三个字节, 分别为费率, 开始时, 开始分 The seventh set of time period tables Each period occupies three bytes. They are respectively the rates. At the beginning, the distribution starts	R/W	21	Uint16	同第一套时段表 The same as the first set of time schedule
0xE0BD	Table8 Rt1~Rt14	第八套时段表, 每个时段占用三个字节, 分别为费率, 开始时, 开始分 The eighth set of time period tables Each period occupies three bytes. They are respectively the rates. At the beginning, the distribution starts	R/W	21	Uint16	同第一套时段表 The same as the first set of time schedule

八费率版（尖峰平谷深谷，其余暂时保留）二次侧电能

Eight rate version (peak flat valley deep valley, the rest temporarily reserved) secondary side power

地址 Address	名称 Name	解释 Explanation	R/W	字长 Word	类型 Type	备注 Note
0xE200	EP	总有功电能二次值 Total active energy quadratic value	R/W	2	Uint32	四位小数 kWh Four decimal kWh

0xE202	EPI	正向有功电能二次值 Positive active energy quadratic value	R/W	2	Uint32	四位小数 kWh Four decimal kWh
0xE204	EPE	反向有功电能二次值 The secondary value of reverse active energy	R/W	2	Uint32	四位小数 kWh Four decimal kWh
0xE206	EQ	总无功电能二次值 The secondary value of total reactive energy	R/W	2	Uint32	四位小数 kVarh Four decimal kVarh
0xE208	EQL	正向无功电能二次值 The secondary value of positive reactive energy	R/W	2	Uint32	四位小数 kVarh Four decimal kVarh
0xE20a	EQC	反向无功电能二次值 The secondary value of reverse reactive energy	R/W	2	Uint32	四位小数 kVarh Four decimal kVarh
0xE20c	ES	视在电能二次值 The secondary value of apparent electrical energy	R/W	2	Uint32	四位小数 kVAh Four decimal kVarh
0xE20e	EP-F1	总有功电能尖二次值 The secondary value of the total active energy peak	R/W	2	Uint32	四位小数 kWh Four decimal kWh
0xE210	EP-F2	总有功电能峰二次值 The secondary value of the peak of total active energy	R/W	2	Uint32	四位小数 kWh Four decimal kWh
0xE212	EP-F3	总有功电能平二次值 Secondary value of total active energy level	R/W	2	Uint32	四位小数 kWh Four decimal kWh
0xE214	EP-F4	总有功电能谷二次值 Secondary value of total active	R/W	2	Uint32	四位小数 kWh

		energy valley				Four decimal kWh
0xE216	EP-F5	总有功电能深谷二次值 Secondary value of total active energy deep valley	R/W	2	Uint32	四位小数 kWh Four decimal kWh
0xE218	EP-F6	保留 Retain	R/W	2	Uint32	四位小数 kWh Four decimal kWh
0xE21a	EP-F7	保留 Retain	R/W	2	Uint32	四位小数 kWh Four decimal kWh
0xE21c	EP-F8	保留 Retain	R/W	2	Uint32	四位小数 kWh Four decimal kWh
0xE21e	EPI-F1	正向有功电能尖二次值 Secondary value of forward active energy tip	R/W	2	Uint32	四位小数 kWh Four decimal kWh
0xE220	EPI-F2	正向有功电能峰二次值 Secondary value of forward active energy peak	R/W	2	Uint32	四位小数 kWh Four decimal kWh
0xE222	EPI-F3	正向有功电能平二次值 Secondary value of forward active energy level	R/W	2	Uint32	四位小数 kWh Four decimal kWh
0xE224	EPI-F4	正向有功电能谷二次值 Secondary value of forward active energy valley	R/W	2	Uint32	四位小数 kWh Four decimal kWh
0xE226	EPI-F5	正向有功电能深谷二次值 Secondary value of forward active energy deep valley	R/W	2	Uint32	四位小数 kWh Four decimal kWh
0xE228	EPI-F6	保留 Retain	R/W	2	Uint32	四位小数 kWh Four decimal kWh
0xE22a	EPI-F7	保留 Retain	R/W	2	Uint32	四位小数 kWh

						Four decimal kWh
0xE22c	EPI-F8	保留 Retain	R/W	2	Uint32	四位小数 kWh Four decimal kWh
0xE22e	EPE-F1	反向有功电能尖二次值 Secondary value of reverse active energy tip	R/W	2	Uint32	四位小数 kWh Four decimal kWh
0xE230	EPE-F2	反向有功电能峰二次值 Secondary value of reverse active energy peak	R/W	2	Uint32	四位小数 kWh Four decimal kWh
0xE232	EPE-F3	反向有功电能平二次值 Secondary value of reverse active energy level	R/W	2	Uint32	四位小数 kWh Four decimal kWh
0xE234	EPE-F4	反向有功电能谷二次值 Secondary value of reverse active energy valley	R/W	2	Uint32	四位小数 kWh Four decimal kWh
0xE236	EPE-F5	反向有功电能深谷二次值 Secondary value of reverse active energy deep valley	R/W	2	Uint32	四位小数 kWh Four decimal kWh
0xE238	EPE-F6	保留 Retain	R/W	2	Uint32	四位小数 kWh Four decimal kWh
0xE23a	EPE-F7	保留 Retain	R/W	2	Uint32	四位小数 kWh Four decimal kWh
0xE23c	EPE-F8	保留 Retain	R/W	2	Uint32	四位小数 kWh Four decimal kWh
0xE23e	EQL-F1	正向无功电能尖二次值 Secondary value of forward reactive energy tip	R/W	2	Uint32	四位小数 kVarh Four decimal kVarh
0xE240	EQL-F2	正向无功电能峰二次值	R/W	2	Uint32	四位小数 kVarh

		Secondary value of forward reactive energy peak				Four decimal kVarh
0xE242	EQL-F3	正向无功电能平二次值 Secondary value of forward reactive energy level	R/W	2	Uin32	四位小数 kVarh Four decimal kVarh
0xE244	EQL-F4	正向无功电能谷二次值 Secondary value of forward reactive energy valley	R/W	2	Uin32	四位小数 kVarh Four decimal kVarh
0xE246	EQL-F5	正向无功电能深谷二次值 Secondary value of forward reactive energy deep valley	R/W	2	Uin32	四位小数 kVarh Four decimal kVarh
0xE248	EQL-F6	保留 Retain	R/W	2	Uin32	四位小数 kVarh Four decimal kVarh
0xE24a	EQL-F7	保留 Retain	R/W	2	Uin32	四位小数 kVarh Four decimal kVarh
0xE24c	EQL-F8	保留 Retain	R/W	2	Uin32	四位小数 kVarh Four decimal kVarh
0xE24e	EQC-F1	反向无功电能尖二次值 Secondary value of reverse reactive energy tip	R/W	2	Uin32	四位小数 kVarh Four decimal kVarh
0xE250	EQC-F2	反向无功电能峰二次值 Secondary value of reverse reactive energy peak	R/W	2	Uin32	四位小数 kVarh Four decimal kVarh
0xE252	EQC-F3	反向无功电能平二次值 Secondary value of reverse reactive energy level	R/W	2	Uin32	四位小数 kVarh Four decimal kVarh
0xE254	EQC-F4	反向无功电能谷二次值 Secondary value of reverse	R/W	2	Uin32	四位小数 kVarh Four decimal kVarh

		reactive energy valley				
0xE256	EQC-F5	反向无功电能深谷二次值 Secondary value of reverse reactive energy deep valley	R/W	2	Uint32	四位小数 kVarh Four decimal kVarh
0xE258	EQC-F6	保留 Retain	R/W	2	Uint32	四位小数 kVarh Four decimal kVarh
0xE25a	EQC-F7	保留 Retain	R/W	2	Uint32	四位小数 kVarh Four decimal kVarh
0xE25c	EQC-F8	保留 Retain	R/W	2	Uint32	四位小数 kVarh Four decimal kVarh
0xE25e	EPA	A 相总有功电能二次值 Secondary value of total active energy of phase A	R/W	2	Uint32	四位小数 kwh Four decimal kwh
0xE260	EPIA	A 相正向有功电能二次值 Phase A forward active energy secondary value	R/W	2	Uint32	四位小数 kwh Four decimal kwh
0xE262	EPEA	A 相反向有功电能二次值 Phase A reverse active energy secondary value	R/W	2	Uint32	四位小数 kwh Four decimal kwh
0xE264	EQA	A 相无功电能二次值 Phase A reactive energy secondary value	R/W	2	Uint32	四位小数 kVarh Four decimal kVarh
0xE266	EQLA	A 相正向无功电能二次值 Phase A forward reactive energy secondary value	R/W	2	Uint32	四位小数 kVarh Four decimal kVarh
0xE268	EQCA	A 相反向无功电能二次值 A reverses to the secondary value of reactive energy	R/W	2	Uint32	四位小数 kVarh Four decimal kVarh

0xE26a	EPIA-F1	A 正向有功电能尖二次值 A forward active energy tip secondary value	R/W	2	Uint32	四位小数 kWh Four decimal kWh
0xE26c	EPIA-F2	A 正向有功电能峰二次值 A forward active energy peak secondary value	R/W	2	Uint32	四位小数 kWh Four decimal kWh
0xE26e	EPIA-F3	A 正向有功电能平二次值 A forward active energy level secondary value	R/W	2	Uint32	四位小数 kWh Four decimal kWh
0xE270	EPIA-F4	A 正向有功电能谷二次值 A forward active energy valley secondary value	R/W	2	Uint32	四位小数 kWh Four decimal kWh
0xE272	EPIA-F5	A 正向有功电能深谷二次值 A forward active energy deep valley secondary value	R/W	2	Uint32	四位小数 kWh Four decimal kWh
0xE274	EPIA-F6	保留 Retain	R/W	2	Uint32	四位小数 kWh Four decimal kWh
0xE276	EPIA-F7	保留 Retain	R/W	2	Uint32	四位小数 kWh Four decimal kWh
0xE278	EPIA-F8	保留 Retain	R/W	2	Uint32	四位小数 kWh Four decimal kWh
0xE27a	EPB	B 相总有功电能二次值 Secondary value of total active energy of phase B	R/W	2	Uint32	四位小数 kWh Four decimal kWh
0xE27c	EPIB	B 相正向有功电能二次值 Phase B forward active energy secondary value	R/W	2	Uint32	四位小数 kWh Four decimal kWh
0xE27e	EPEB	B 相反向有功电能二次值	R/W	2	Uint32	四位小数 kWh

		Phase B reverse active energy secondary value				Four decimal kWh
0xE280	EQB	B 相无功电能二次值 B-phase reactive energy Secondary value	R/W	2	Uint32	四位小数 kVarh Four decimal kVarh
0xE282	EQLB	B 相正向无功电能二次值 B-Phase forward reactive energy secondary value	R/W	2	Uint32	四位小数 kVarh Four decimal kVarh
0xE284	EQCB	B 相反向无功电能二次值 B-Phase reverse reactive energy secondary value	R/W	2	Uint32	四位小数 kVarh Four decimal kVarh
0xE286	EPIB-F1	B 正向有功电能尖二次值 B forward active energy tip secondary value	R/W	2	Uint32	四位小数 kWh Four decimal kWh
0xE288	EPIB-F2	B 正向有功电能峰二次值 B forward active energy peak secondary value	R/W	2	Uint32	四位小数 kWh Four decimal kWh
0xE28a	EPIB-F3	B 正向有功电能平二次值 B forward active energy level secondary value	R/W	2	Uint32	四位小数 kWh Four decimal kWh
0xE28c	EPIB-F4	B 正向有功电能谷二次值 B forward active energy valley secondary value	R/W	2	Uint32	四位小数 kWh Four decimal kWh
0xE28e	EPIB-F5	B 正向有功电能深谷二次值 B forward active energy deep valley secondary value	R/W	2	Uint32	四位小数 kWh Four decimal kWh
0xE290	EPIB-F6	保留 Retain	R/W	2	Uint32	四位小数 kWh Four decimal kWh

0xE292	EPIB-F7	保留 Retain	R/W	2	Uint32	四位小数 kWh Four decimal kWh
0xE294	EPIB-F8	保留 Retain	R/W	2	Uint32	四位小数 kWh Four decimal kWh
0xE296	EPC	C 相总有功电能二次值 Secondary value of total active energy of phase C	R/W	2	Uint32	四位小数 kWh Four decimal kWh
0xE298	EPIC	C 相正向有功电能二次值 Phase C forward active energy secondary value	R/W	2	Uint32	四位小数 kWh Four decimal kWh
0xE29a	EPEC	C 相反向有功电能二次值 Phase C reverse active energy secondary value	R/W	2	Uint32	四位小数 kWh Four decimal kWh
0xE29c	EQC	C 相无功电能二次值 C-phase reactive energy Secondary value	R/W	2	Uint32	四位小数 kVarh Four decimal kVarh
0xE29e	EQLC	C 相正向无功电能二次值 C-Phase forward reactive energy secondary value	R/W	2	Uint32	四位小数 kVarh Four decimal kVarh
0xE2a0	EQCC	C 相反向无功电能二次值 C-Phase reverse reactive energy secondary value	R/W	2	Uint32	四位小数 kVarh Four decimal kVarh
0xE2a2	EPIC-F1	C 正向有功电能尖二次值 C forward active energy tip secondary value	R/W	2	Uint32	四位小数 kWh Four decimal kWh
0xE2a4	EPIC-F2	C 正向有功电能峰二次值 C forward active energy peak secondary value	R/W	2	Uint32	四位小数 kWh Four decimal kWh

0xE2a6	EPIC-F3	C 正向有功电能平二次值 C forward active energy level secondary value	R/W	2	Uint32	四位小数 kWh Four decimal kWh
0xE2a8	EPIC-F4	C 正向有功电能谷二次值 C forward active energy valley secondary value	R/W	2	Uint32	四位小数 kWh Four decimal kWh
0xE2aa	EPIC-F5	C 正向有功电能深谷二次值 C forward active energy deep valley secondary value	R/W	2	Uint32	四位小数 kWh Four decimal kWh
0xE2ac	EPIC-F6	保留 Retain	R/W	2	Uint32	四位小数 kWh Four decimal kWh
0xE2ae	EPIC-F7	保留 Retain	R/W	2	Uint32	四位小数 kWh Four decimal kWh
0xE2b0	EPIC-F8	保留 Retain	R/W	2	Uint32	四位小数 kWh Four decimal kWh
0xE2b2	EQ1_1	象限 1 总无功电能二次值 Quadrant 1 Quadratic value of total reactive energy	R/W	2	Uint32	四位小数 kVarh Four decimal kVarh
0xE2b4	EQ1_2	象限 2 总无功电能二次值 Quadrant 2 Quadratic value of total reactive energy	R/W	2	Uint32	四位小数 kVarh Four decimal kVarh
0xE2b6	EQ1_3	象限 3 总无功电能二次值 Quadrant 3 Quadratic value of total reactive energy	R/W	2	Uint32	四位小数 kVarh Four decimal kVarh
0xE2b8	EQ1_4	象限 4 总无功电能二次值 Quadrant 4 Quadratic value of	R/W	2	Uint32	四位小数 kVarh Four decimal kVarh

		total reactive energy				
0xE2ba	EPCL	总有功电能净二次值 Net quadratic value of total active energy	R/W	2	Uint32	四位小数 kWh Four decimal kWh
0xE2bc	EQCL	总无功电能净二次值 Net quadratic value of total reactive energy	R/W	2	Uint32	四位小数 kWh Four decimal kWh
八费率版（尖峰平谷深谷，其余暂时保留）一次侧电能：按照浮点型读出之后除 10000 后，为实际电能						
0xE300	EP	总有功电能一次值 The primary value of total active energy	R/W	2	float	四位小数 kWh Four decimal kWh
0xE302	EPI	正向有功电能一次值 The primary value of positive active energy	R/W	2	float	四位小数 kWh Four decimal kWh
0xE304	EPE	反向电能一次值 Primary value of reverse electrical energy	R/W	2	float	四位小数 kWh Four decimal kWh
0xE306	EQ	总无功电能一次值 Primary value of total reactive energy	R/W	2	float	四位小数 kVarh Four decimal kVarh
0xE308	EQL	正向无功电能一次值 Primary value of forward reactive energy	R/W	2	float	四位小数 kVarh Four decimal kVarh
0xE30a	EQC	反向无功电能一次值 Primary value of reverse reactive energy	R/W	2	float	四位小数 kVarh Four decimal kVarh
0xE30c	ES	视在电能一次值 Primary value of apparent electrical	R/W	2	float	四位小数 kVAh Four decimal

		energy				kVarh
0xE30e	EP-F1	总有功电能尖一次值 Primary value of total active energy tip	R/W	2	float	四位小数 kWh Four decimal kWh
0xE310	EP-F2	总有功电能峰一次值 Primary value of total active energy peak	R/W	2	float	四位小数 kWh Four decimal kWh
0xE312	EP-F3	总有功电能平一次值 Primary value of total active energy level	R/W	2	float	四位小数 kWh Four decimal kWh
0xE314	EP-F4	总有功电能谷一次值 Primary value of total active energy valley	R/W	2	float	四位小数 kWh Four decimal kWh
0xE316	EP-F5	总有功电能深谷一次值 Primary value of total active energy deep valley	R/W	2	float	四位小数 kWh Four decimal kWh
0xE318	EP-F6	保留 Retain	R/W	2	float	四位小数 kWh Four decimal kWh
0xE31a	EP-F7	保留 Retain	R/W	2	float	四位小数 kWh Four decimal kWh
0xE31c	EP-F8	保留 Retain	R/W	2	float	四位小数 kWh Four decimal kWh
0xE31e	EPI-F1	正向有功电能尖一次值 Primary value of forward active energy tip	R/W	2	float	四位小数 kWh Four decimal kWh
0xE320	EPI-F2	正向有功电能峰一次值 Primary value of forward active energy peak	R/W	2	float	四位小数 kWh Four decimal kWh

0xE322	EPI-F3	正向有功电能平一次值 Primary value of forward active energy level	R/W	2	float	四位小数 kWh Four decimal kWh
0xE324	EPI-F4	正向有功电能谷一次值 Primary value of forward active energy valley	R/W	2	float	四位小数 kWh Four decimal kWh
0xE326	EPI-F5	正向有功电能深谷一次值 Primary value of forward active energy deep valley	R/W	2	float	四位小数 kWh Four decimal kWh
0xE328	EPI-F6	保留 Retain	R/W	2	float	四位小数 kWh Four decimal kWh
0xE32a	EPI-F7	保留 Retain	R/W	2	float	四位小数 kWh Four decimal kWh
0xE32c	EPI-F8	保留 Retain	R/W	2	float	四位小数 kWh Four decimal kWh
0xE32e	EPE-F1	反向有功电能尖一次值 Primary value of reverse active energy tip	R/W	2	float	四位小数 kWh Four decimal kWh
0xE330	EPE-F2	反向有功电能峰一次值 Primary value of reverse active energy peak	R/W	2	float	四位小数 kWh Four decimal kWh
0xE332	EPE-F3	反向有功电能平一次值 Primary value of reverse active energy level	R/W	2	float	四位小数 kWh Four decimal kWh
0xE334	EPE-F4	反向有功电能谷一次值 Primary value of reverse active energy valley	R/W	2	float	四位小数 kWh Four decimal kWh
0xE336	EPE-F5	反向有功电能深谷一次值	R/W	2	float	四位小数 kWh

		Primary value of reverse active energy deep valley				Four decimal kWh
0xE338	EPE-F6	保留 Retain	R/W	2	float	四位小数 kWh Four decimal kWh
0xE33a	EPE-F7	保留 Retain	R/W	2	float	四位小数 kWh Four decimal kWh
0xE33c	EPE-F8	保留 Retain	R/W	2	float	四位小数 kWh Four decimal kWh
0xE33e	EQL-F1	正向无功电能尖一次值 Primary value of forward reactive energy tip	R/W	2	float	四位小数 kVarh Four decimal kVarh
0xE340	EQL-F2	正向无功电能峰一次值 Primary value of forward reactive energy peak	R/W	2	float	四位小数 kVarh Four decimal kVarh
0xE342	EQL-F3	正向无功电能平一次值 Primary value of forward reactive energy level	R/W	2	float	四位小数 kVarh Four decimal kVarh
0xE344	EQL-F4	正向无功电能谷一次值 Primary value of forward reactive energy valley	R/W	2	float	四位小数 kVarh Four decimal kVarh
0xE346	EQL-F5	正向无功电能深谷一次值 Primary value of forward reactive energy deep valley	R/W	2	float	四位小数 kVarh Four decimal kVarh
0xE348	EQL-F6	保留 Retain	R/W	2	float	四位小数 kVarh Four decimal kVarh
0xE34a	EQL-F7	保留 Retain	R/W	2	float	四位小数 kVarh Four decimal kVarh
0xE34c	EQL-F8	保留	R/W	2	float	四位小数 kVarh

		Retain				Four decimal kVarh
0xE34e	EQC-F1	反向无功电能尖一次值 Primary value of reverse reactive energy tip	R/W	2	float	四位小数 kVarh Four decimal kVarh
0xE350	EQC-F2	反向无功电能峰一次值 Primary value of reverse reactive energy level	R/W	2	float	四位小数 kVarh Four decimal kVarh
0xE352	EQC-F3	反向无功电能平一次值 Primary value of reverse reactive energy level	R/W	2	float	四位小数 kVarh Four decimal kVarh
0xE354	EQC-F4	反向无功电能谷一次值 Primary value of reverse reactive energy valley	R/W	2	float	四位小数 kVarh Four decimal kVarh
0xE356	EQC-F5	反向无功电能深谷一次值 Primary value of reverse reactive energy valley	R/W	2	float	四位小数 kVarh Four decimal kVarh
0xE358	EQC-F6	保留 Retain	R/W	2	float	四位小数 kVarh Four decimal kVarh
0xE35a	EQC-F7	保留 Retain	R/W	2	float	四位小数 kVarh Four decimal kVarh
0xE35c	EQC-F8	保留 Retain	R/W	2	float	四位小数 kVarh Four decimal kVarh
0xE35e	EPA	A 相总有功电能一次值 Primary value of total active energy of phase A	R/W	2	float	四位小数 kWh Four decimal kWh
0xE360	EPIA	A 相正向有功电能一次值 Phase A forward active energy Primary value	R/W	2	float	四位小数 kWh Four decimal kWh

0xE362	EPEA	A 相反向有功电能一次值 Phase A reverse active energy Primary value	R/W	2	float	四位小数 kWh Four decimal kWh
0xE364	EQA	A 相无功电能一次值 Phase A reactive energy Primary value	R/W	2	float	四位小数 kVarh Four decimal kVarh
0xE366	EQLA	A 相正向无功电能一次值 Phase A forward reactive energy Primary value	R/W	2	float	四位小数 kVarh Four decimal kVarh
0xE368	EQCA	A 相反向无功电能一次值 A reverses to the Primary value of reactive energy	R/W	2	float	四位小数 kVarh Four decimal kVarh
0xE36a	EPIA-F1	A 正向有功电能尖一次值 A forward active energy tip Primary value	R/W	2	float	四位小数 kWh Four decimal kWh
0xE36c	EPIA-F2	A 正向有功电能峰一次值 A forward active energy peak Primary value	R/W	2	float	四位小数 kWh Four decimal kWh
0xE36e	EPIA-F3	A 正向有功电能平一次值 A forward active energy level Primary value	R/W	2	float	四位小数 kWh Four decimal kWh
0xE370	EPIA-F4	A 正向有功电能谷一次值 A forward active energy valley Primary value	R/W	2	float	四位小数 kWh Four decimal kWh
0xE372	EPIA-F5	A 正向有功电能深谷一次值 A forward active energy deep valley Primary value	R/W	2	float	四位小数 kWh Four decimal kWh
0xE374	EPIA-F6	保留	R/W	2	float	四位小数 kWh

		Retain				Four decimal kWh
0xE376	EPIA-F7	保留 Retain	R/W	2	float	四位小数 kWh Four decimal kWh
0xE378	EPIA-F8	保留 Retain	R/W	2	float	四位小数 kWh Four decimal kWh
0xE37a	EPB	B 相总有功电能一次值 Primary value of total active energy of phase B	R/W	2	float	四位小数 kWh Four decimal kWh
0xE37c	EPIB	B 相正向有功电能一次值 Phase B forward active energy Primary value	R/W	2	float	四位小数 kWh Four decimal kWh
0xE37e	EPEB	B 相反向有功电能一次值 B-Phase reverse active energy Primary value	R/W	2	float	四位小数 kWh Four decimal kWh
0xE380	EQB	B 相无功电能一次值 B-phase reactive energy Primary value	R/W	2	float	四位小数 kVarh Four decimal kVarh
0xE382	EQLB	B 相正向无功电能一次值 B-Phase forward reactive energy Primary value	R/W	2	float	四位小数 kVarh Four decimal kVarh
0xE384	EQCB	B 相反向无功电能一次值 B-Phase reverse reactive energy Primary value	R/W	2	float	四位小数 kVarh Four decimal kVarh
0xE386	EPIB-F1	B 正向有功电能尖一次值 B forward active energy tip Primary value	R/W	2	float	四位小数 kWh Four decimal kWh
0xE388	EPIB-F2	B 正向有功电能峰一次值 B forward active energy peak	R/W	2	float	四位小数 kWh Four decimal kWh

		Primary value				
0xE38a	EPIB-F3	B 正向有功电能平一次值 B forward active energy level Primary value	R/W	2	float	四位小数 kWh Four decimal kWh
0xE38c	EPIB-F4	B 正向有功电能谷一次值 B forward active energy valley Primary value	R/W	2	float	四位小数 kWh Four decimal kWh
0xE38e	EPIB-F5	B 正向有功电能深谷一次值 B forward active energy deep valley Primary value	R/W	2	float	四位小数 kWh Four decimal kWh
0xE390	EPIB-F6	保留 Retain	R/W	2	float	四位小数 kWh Four decimal kWh
0xE392	EPIB-F7	保留 Retain	R/W	2	float	四位小数 kWh Four decimal kWh
0xE394	EPIB-F8	保留 Retain	R/W	2	float	四位小数 kWh Four decimal kWh
0xE396	EPC	C 相总有功电能一次值 Primary value of total active energy of phase C	R/W	2	float	四位小数 kWh Four decimal kWh
0xE398	EPIC	C 相正向有功电能一次值 C-Phase forward active energy Primary value	R/W	2	float	四位小数 kWh Four decimal kWh
0xE39a	EPEC	C 相反向有功电能一次值 C-Phase reverse active energy	R/W	2	float	四位小数 kWh Four decimal kWh
0xE39c	EQC	C 相无功电能一次值 C-phase reactive energy Primary value	R/W	2	float	四位小数 kVarh Four decimal kVarh
0xE39e	EQLC	C 相正向无功电能一次值	R/W	2	float	四位小数 kVarh

		C-Phase forward reactive energy Primary value				Four decimal kVarh
0xE3a0	EQCC	C 相反向无功电能一次值 C-Phase reverse reactive energy Primary value	R/W	2	float	四位小数 kVarh Four decimal kVarh
0xE3a2	EPIC-F1	C 正向有功电能尖一次值 C forward active energy tip Primary value	R/W	2	float	四位小数 kWh Four decimal kWh
0xE3a4	EPIC-F2	C 正向有功电能峰一次值 C forward active energy peak Primary value	R/W	2	float	四位小数 kWh Four decimal kWh
0xE3a6	EPIC-F3	C 正向有功电能平一次值 C forward active energy level Primary value	R/W	2	float	四位小数 kWh Four decimal kWh
0xE3a8	EPIC-F4	C 正向有功电能谷一次值 C forward active energy valley Primary value	R/W	2	float	四位小数 kWh Four decimal kWh
0xE3aa	EPIC-F5	C 正向有功电能深谷一次值 C forward active energy deep valley Primary value	R/W	2	float	四位小数 kWh Four decimal kWh
0xE3ac	EPIC-F6	保留 Retain	R/W	2	float	四位小数 kWh Four decimal kWh
0xE3ae	EPIC-F7	保留 Retain	R/W	2	float	四位小数 kWh Four decimal kWh
0xE3b0	EPIC-F8	保留 Retain	R/W	2	float	四位小数 kWh Four decimal kWh
0xE3b2	EQ1_1	象限 1 总无功电能一次值 Quadrant 1 total reactive energy	R/W	2	float	四位小数 kVarh Four decimal kVarh

		primary value				
0xE3b4	EQ1_2	象限 2 总无功电能一次值 Quadrant 2 total reactive energy primary value	R/W	2	float	四位小数 kVarh Four decimal kVarh
0xE3b6	EQ1_3	象限 3 总无功电能一次值 Quadrant 3 total reactive energy primary value	R/W	2	float	四位小数 kVarh Four decimal kVarh
0xE3b8	EQ1_4	象限 4 总无功电能一次值 Quadrant 4 total reactive energy primary value	R/W	2	float	四位小数 kVarh Four decimal kVarh
0xE3ba	EPCL	总有功电能净一次值 Net primary value of total active energy	R/W	2	float	四位小数 kWh Four decimal kWh
0xE3bc	EQCL	总无功电能净一次值 Net primary value of total reactive energy	R/W	2	float	四位小数 kVarh Four decimal kVarh

历史 12 月电能

12 months of electricity in history

0xC000	历史一月正向总 The total active electric energy in the positive direction in January of history	R	2	float	四位小数 kWh Four decimal kWh
0XC002	历史一月正向尖 The peak active energy in the positive direction for January in history	R	2	float	四位小数 kWh Four decimal kWh
0XC004	历史一月正向峰 The forward - looking active peak electric energy in January of history	R	2	float	四位小数 kWh Four decimal kWh
0XC006	历史一月正向平 The forward - active flat - rate electric energy in January of history	R	2	float	四位小数 kWh Four decimal kWh

0XC008	历史一月正向谷 The forward - active valley electric energy in January of history	R	2	float	四位小数 kWh Four decimal kWh
0XC00A	历史一月正向深谷 The forward - active deep - valley electric energy in January of history	R	2	float	四位小数 kWh Four decimal kWh
0XC00C	历史一月正向 6 The sixth - rate forward - active electric energy in January of history.	R	2	float	四位小数 kWh Four decimal kWh
0XC00E	历史一月正向 7 The 7th - rate forward - active electric energy in January of history	R	2	float	四位小数 kWh Four decimal kWh
0XC010	历史一月正向 8 The 8th - rate forward - active electricity energy in January of history.	R	2	float	四位小数 kWh Four decimal kWh
0XC012	历史二月正向电能 The forward - direction electric energy in February of history	R	18	float	四位小数 kWh Four decimal kWh
0XC024	历史三月正向电能 The forward - direction electric energy in March of history	R	18	float	四位小数 kWh Four decimal kWh
0XC036	历史四月正向电能 The forward - direction electric energy in April of history	R	18	float	四位小数 kWh Four decimal kWh
0XC048	历史五月正向电能 The forward - direction electric energy in May of history	R	18	float	四位小数 kWh Four decimal kWh
0XC05A	历史六月正向电能 The forward - direction electric energy in June of history	R	18	float	四位小数 kWh Four decimal kWh

0XC06C	历史七月正向电能 The forward - direction electric energy in July of history	R	18	float	四位小数 kWh Four decimal kWh
0XC07E	历史八月正向电能 The forward - direction electric energy in August of history	R	18	float	四位小数 kWh Four decimal kWh
0XC090	历史九月正向电能 The forward - direction electric energy in September of history	R	18	float	四位小数 kWh Four decimal kWh
0XC0A2	历史十月正向电能 The forward - direction electric energy in October of history	R	18	float	四位小数 kWh Four decimal kWh
0XC0B4	历史十一月正向电能 The forward - direction electric energy in November of history	R	18	float	四位小数 kWh Four decimal kWh
0XC0C6	历史十二月正向电能 The forward - direction electric energy in December of history	R	18	float	四位小数 kWh Four decimal kWh
0xC100	历史一月反向总 The total reverse active electric energy in January of history	R	2	float	四位小数 kWh Four decimal kWh
0XC102	历史一月反向尖 The reverse active peak electric energy (sharp period) in January of history	R	2	float	四位小数 kWh Four decimal kWh
0XC104	历史一月反向峰 The reverse active peak electric energy in January of history	R	2	float	四位小数 kWh Four decimal kWh
0XC106	历史一月反向平 The reverse active flat electric energy in January of history	R	2	float	四位小数 kWh Four decimal kWh

0XC108	历史一月反向谷 The reverse active valley electric energy in January of history	R	2	float	四位小数 kWh Four decimal kWh
0XC10A	历史一月反向深谷 The reverse active deep-valley electric energy in January of history	R	2	float	四位小数 kWh Four decimal kWh
0XC10C	历史一月反向 6 The reverse active electric energy at the sixth rate in January of history	R	2	float	四位小数 kWh Four decimal kWh
0XC10E	历史一月反向 7 The reverse active electric energy at the seventh rate in January of history	R	2	float	四位小数 kWh Four decimal kWh
0XC110	历史一月反向 8 The reverse active electric energy at the eighth rate in January of history	R	2	float	四位小数 kWh Four decimal kWh
0XC112	历史二月反向电能 The reverse - direction electric energy in February of history	R	18	float	四位小数 kWh Four decimal kWh
0XC124	历史三月反向电能 The reverse - direction electric energy in March of history	R	18	float	四位小数 kWh Four decimal kWh
0XC136	历史四月反向电能 The reverse - direction electric energy in April of history	R	18	float	四位小数 kWh Four decimal kWh
0XC148	历史五月反向电能 The reverse - direction electric energy in May of history	R	18	float	四位小数 kWh Four decimal kWh
0XC15A	历史六月反向电能 The reverse - direction electric energy in June of history	R	18	float	四位小数 kWh Four decimal kWh

0XC16C	历史七月反向电能 The reverse - direction electric energy in July of history	R	18	float	四位小数 kWh Four decimal kWh
0XC17E	历史八月反向电能 The reverse - direction electric energy in August of history	R	18	float	四位小数 kWh Four decimal kWh
0XC190	历史九月反向电能 The reverse - direction electric energy in September of history	R	18	float	四位小数 kWh Four decimal kWh
0XC1A2	历史十月反向电能 The reverse - direction electric energy in October of history	R	18	float	四位小数 kWh Four decimal kWh
0XC1B4	历史十一月反向电能 The reverse - direction electric energy in November of history	R	18	float	四位小数 kWh Four decimal kWh
0XC1C6	历史十二月反向电能 The reverse - direction electric energy in December of history	R	18	float	四位小数 kWh Four decimal kWh

仪表电需量信息区（功能码 03H 、04H）

Instrument power demand information area (Function codes 03H, 04H)

0x4000	IAdemand	A 相电流实时需量 Real-time demand for Phase A current	R	2	float	A
0x4002	IBdemand	B 相电流实时需量 Real-time demand for Phase B current	R	2	float	A
0x4004	ICdemand	C 相电流实时需量 Real-time demand for phase C current	R	2	float	A
0x4006	Pdemand	总有功功率实时需量 The real-time demand for total active power	R	2	float	kw
0x4008	QHourdemand	总无功功率实时需量	R	2	float	kvar

		Real-time demand for total reactive power				
0x400a	SHourdemand	总视在功率实时需量 The real-time demand for total apparent power	R	2	float	kva
0x4062	IAMonthdemand	A 相电流当月最大需量 The maximum demand for phase A current in the current month	R	2	float	A
0x4064	IAMonthdemandTime	A 相电流当月需量发生时间 The occurrence time of the monthly demand for phase A current	R	2	Uint16	月, 日, 时, 分 Month, Day, Hour, Minute
0x4066	IBMonthdemand	B 相电流当月最大需量 The maximum demand for Phase B current in the current month	R	2	float	A
0x4068	IBMonthdemandTime	B 相电流当月需量发生时间 The occurrence time of the monthly demand for phase B current	R	2	Uint16	月, 日, 时, 分 Month, Day, Hour, Minute
0x406a	ICMonthdemand	C 相电流当月最大需量 The maximum demand for phase C current in the current month	R	2	float	A
0x406c	ICMonthdemandTime	C 相电流当月需量发生时间 The occurrence time of the monthly demand for phase C current	R	2	Uint16	月, 日, 时, 分 Month, Day, Hour, Minute
0x407a	PPMonthdemand	总正向有功功率当月最大需量 The maximum demand for total positive active power in the current month	R	2	float	kw
0x407c	PPMonthdemandTime	总有正向有功功率当月需量发生时间 There is always a time when the positive power demand occurs in the current month	R	2	Uint16	月, 日, 时, 分 Month, Day, Hour, Minute

0x407e	PNMonthdemand	总反向有功功率当月最大需量 The maximum demand for total reverse active power in the current month	R	2	float	kw
0x4080	PNMonthdemandTime	总反向有功功率当月需量发生时间 The occurrence time of the monthly demand for total reverse active power	R	2	Uint16	月, 日, 时, 分 Month, Day, Hour, Minute
0x4082	QPMonthdemand	总正向无功功率当月最大需量 The maximum demand for total positive reactive power in the current month	R	2	float	kvar
0x4084	QPMonthdemandTime	总正向无功功率当月需量发生时间 The occurrence time of the monthly demand for total positive reactive power	R	2	Uint16	月, 日, 时, 分 Month, Day, Hour, Minute
0x4086	QMonthdemand	总反向无功功率当月最大需量 The maximum demand for total reverse reactive power in the current month	R	2	float	kvar
0x4088	QMonthdemandTime	总反向无功功率当月需量发生时间 The occurrence time of the monthly demand for total reverse reactive power	R	2	Uint16	月, 日, 时, 分 Month, Day, Hour, Minute
0x408A	SMonthdemand	总正向视在功率当月最大需量 The total positive apparent power is the maximum demand for the month	R	2	float	kvar
0x408C	SMonthdemandTime	总正向视在功率当月需量发生时间 The occurrence time of the total positive apparent power demand in the current month	R	2	Uint16	月, 日, 时, 分 Month, Day, Hour, Minute
0x408E	SMonthdemand	总反向视在功率当月最大需量 The total reverse apparent power is the maximum demand for the current month	R	2	float	kvar
0x4090	SMonthdemandTime	总反向视在功率当月需量发生时间 The total reverse apparent power is the time when the	R	2	Uint16	月, 日, 时, 分 Month, Day, Hour,

		monthly demand occurs				Minute
--	--	-----------------------	--	--	--	--------

仪表极值信息区（功能码 03H、04H）

Instrument extreme value information area (Function codes 03H, 04H)

区间首地址 The starting address of the interval	历史数据 Historical data
0x93	当月极大值记录 Record of the maximum value of the month
0x94	上1月极大值 The maximum value of last month
0x97	当月极小值记录 The minimum value record of the current month
0x98	上1月极小值 The minimum value of last month

如：0x9300 表示当月 A 相电压极大值

偏移地址、 address	名称 name	解释 Explanation	读/写	字长 word	类型 type	
0x00	UA	A 相电压 Phase A voltage	R	2	float	V
0x02	UATime	A 相电压极值发生时间 The occurrence time of the extreme value of phase A voltage	R	3	Uint16	年, 月, 日, 时, 分, 秒 Year, Month, Day, Hour, Minute, Second
0x05	UB	B 相电压 Phase B voltage	R	2	float	V
0x07	UBTime	B 相电压极值发生时间 The occurrence time of the extreme value of phase B voltage	R	3	Uint16	年, 月, 日, 时, 分, 秒 Year, Month, Day, Hour, Minute, Second
0x0a	UC	C 相电压 Phase C voltage	R	2	float	V
0x0c	UCTime	C 相电压极值发生时间 The occurrence time of the extreme value of phase C voltage	R	3	Uint16	年, 月, 日, 时, 分, 秒 Year, Month, Day, Hour, Minute, Second
0x0f	UAB	AB 线电压 Voltage of Line AB	R	2	float	V

0x11	UABTime	AB 线电压极值发生时间 The occurrence time of the voltage extreme value of line AB	R	3	Uint16	年, 月, 日, 时, 分, 秒 Year, Month, Day, Hour, Minute, Second
0x14	UBC	BC 线电压 Voltage of Line BC	R	2	float	V
0x16	UBCTime	BC 线电压极值发生时间 The occurrence time of the voltage extreme value of line BC	R	3	Uint16	月, 日, 时, 分 Month, Day, Hour, Minute
0x19	UCA	CA 线电压 Voltage of Line CA	R	2	float	V
0x1b	UCATime	CA 线电压极值发生时间 The occurrence time of the voltage extreme value of line CA	R	3	Uint16	年, 月, 日, 时, 分, 秒 Year, Month, Day, Hour, Minute, Second
0x1e	IA	A 相电流 Phase A current	R	2	float	A
0x20	IATime	A 相电流极值发生时间 The occurrence time of the extreme value of phase A current	R	3	Uint16	年, 月, 日, 时, 分, 秒 Year, Month, Day, Hour, Minute, Second
0x23	IB	B 相电流 Phase B current	R	2	float	A
0x25	IBTime	B 相电流极值当发生时间 The occurrence time of the extreme value of phase B current	R	3	Uint16	年, 月, 日, 时, 分, 秒 Year, Month, Day, Hour, Minute, Second
0x28	IC	C 相电流 Phase C current	R	2	float	A
0x2a	ICTime	C 相电流极值发生时间 The occurrence time of the extreme value of phase C current	R	3	Uint16	年, 月, 日, 时, 分, 秒 Year, Month, Day, Hour, Minute, Second

0x2d	IN	N 线电流 N-line current	R	2	float	A
0x2f	INTime	N 相电流极值发生时间 The occurrence time of the extreme value of the N-phase current	R	3	Uint16	年, 月, 日, 时, 分, 秒 Year, Month, Day, Hour, Minute, Second
0x32	PA	A 相有功功率 Active power of Phase A	R	2	float	KW
0x34	PATime	A 相有功功率极值发生时间 The occurrence time of the extreme value of active power in phase A	R	3	Uint16	年, 月, 日, 时, 分, 秒 Year, Month, Day, Hour, Minute, Second
0x37	PB	B 相有功功率 Active power of Phase B	R	2	float	KW
0x39	PBTime	B 相有功功率极值发生时间 The occurrence time of the extreme value of active power in phase B	R	3	Uint16	年, 月, 日, 时, 分, 秒 Year, Month, Day, Hour, Minute, Second
0x3c	PC	C 相有功功率 Active power of Phase C	R	2	float	KW
0x3e	PCTime	C 相有功功率极值发生时间 The occurrence time of the extreme value of active power in phase C	R	3	Uint16	年, 月, 日, 时, 分, 秒 Year, Month, Day, Hour, Minute, Second
0x41	PT	总有功功率 Total active power	R	2	float	KW
0x43	PTTime	总有功功率极值发生时间 The occurrence time of the extreme value of total active power	R	3	Uint16	年, 月, 日, 时, 分, 秒 Year, Month, Day, Hour, Minute, Second
0x46	QA	A 相无功功率 Reactive power of Phase A	R	2	float	Kvar
0x48	QATime	A 相无功功率极值发生时间	R	3	Uint16	年, 月, 日, 时, 分, 秒

		The occurrence time of the extreme value of reactive power in phase A				Year, Month, Day, Hour, Minute, Second
0x4b	QB	B相无功功率 Reactive power of Phase B	R	2	float	Kvar
0x4d	QBTime	B相无功功率极值发生时间 The occurrence time of the extreme reactive power of phase B	R	3	Uint16	年, 月, 日, 时, 分, 秒 Year, Month, Day, Hour, Minute, Second
0x50	QC	C相无功功率 Reactive power of Phase C	R	2	float	Kvar
0x52	QCTime	C相无功功率极值发生时间 The occurrence time of the extreme reactive power of phase C	R	3	Uint16	年, 月, 日, 时, 分, 秒 Year, Month, Day, Hour, Minute, Second
0x55	QT	总无功功率 Total reactive power	R	2	float	Kvar
0x57	QTTime	总无功功率极值发生时间 The occurrence time of the extreme value of total reactive power	R	3	Uint16	年, 月, 日, 时, 分, 秒 Year, Month, Day, Hour, Minute, Second
0x5a	SA	A相视在功率 The relative power of A	R	2	float	KVA
0x5c	SATime	A相视在功率极值发生时间 The occurrence time of phase A at the power extreme value	R	3	Uint16	月, 日, 时, 分 Month, Day, Hour, Minute
0x5f	SB	B相视在功率 The relative power of B	R	2	float	KVA
0x61	SBTime	B相视在功率极值发生时间 The occurrence time of phase B at the power extreme value	R	3	Uint16	年, 月, 日, 时, 分, 秒 Year, Month, Day, Hour, Minute, Second
0x64	SC	C相视在功率	R	2	float	KVA

		The relative power of C				
0x66	SCTime	C 相视在功率极值发生时间 The occurrence time of phase C at the power extreme value	R	3	Uint16	年, 月, 日, 时, 分, 秒 Year, Month, Day, Hour, Minute, Second
0x69	ST	总视在功率 Total apparent power	R	2	float	KVA
0x6b	STTime	总视在功率极值发生时间 The occurrence time of the total apparent power extremum	R	3	Uint16	年, 月, 日, 时, 分, 秒 Year, Month, Day, Hour, Minute, Second
0x6e	PFA	A 相功率因数 Power factor of Phase A	R	2	float	
0x70	PFATime	A 相功率因数极值发生时间 The occurrence time of the extreme value of phase A power factor	R	3	Uint16	年, 月, 日, 时, 分, 秒 Year, Month, Day, Hour, Minute, Second
0x73	PFB	B 相功率因数 Power factor of Phase B	R	2	float	
0x75	PFBTime	B 相功率因数极值发生时间 The occurrence time of the extreme value of phase B power factor	R	3	Uint16	年, 月, 日, 时, 分, 秒 Year, Month, Day, Hour, Minute, Second
0x78	PFC	C 相功率因数 Power factor of Phase C	R	2	float	
0x7a	PFCTime	C 相功率因数极值发生时间 The occurrence time of the extreme value of phase C power factor	R	3	Uint16	年, 月, 日, 时, 分, 秒 Year, Month, Day, Hour, Minute, Second
0x7d	PF	总功率因数 Total power factor	R	2	float	
0x7f	PFTime	总功率因数极值发生时间 The occurrence time of the extreme	R	3	Uint16	年, 月, 日, 时, 分, 秒 Year, Month, Day, Hour, M

		value of the total power factor				minute, Second
0x82	UNAvg	相电压平均值 Average value of phase voltage	R	2	float	V
0x84	UNAvgTime	相电压平均值极值发生时间 The occurrence time of the extreme value of the average phase voltage	R	3	Uint16	年, 月, 日, 时, 分, 秒 Year, Month, Day, Hour, Minute, Second
0x87	ULAvg	线电压平均值 Average value of line voltage	R	2	float	V
0x89	ULAvgTime	线电压平均值极值发生时间 The occurrence time of the extreme value of the average line voltage	R	3	Uint16	年, 月, 日, 时, 分, 秒 Year, Month, Day, Hour, Minute, Second
0x8c	IAvg	电流平均值 Average value of current	R	2	float	A
0x8e	IAvgTime	电流平均值极值发生时间 The occurrence time of the extreme value of the average current	R	3	Uint16	年, 月, 日, 时, 分, 秒 Year, Month, Day, Hour, Minute, Second
0x91	THDUaP	A 相电压总谐波含有率 Total harmonic content rate of phase A voltage	R	2	Uint16	0.1%
0x93	THDUaPTime	A 相电压总谐波极值发生时间 The occurrence time of the total harmonic extreme value of phase A voltage	R	3	Uint16	年, 月, 日, 时, 分, 秒 Year, Month, Day, Hour, Minute, Second
0x96	THDUbP	B 相电压总谐波含有率 Total harmonic content rate of phase B voltage	R	2	Uint16	0.1%
0x98	THDUbPTime	B 相电压总谐波极值发生时间 The occurrence time of the total	R	3	Uint16	年, 月, 日, 时, 分, 秒 Year, Month, Day, Hour, Minute, Second

		harmonic extreme value of phase B voltage				minute, Second
0x9B	THDUcP	C 相电压总谐波含有率 Total harmonic content rate of phase C voltage	R	2	Uint16	0.1%
0x9D	THDUcPTime	C 相电压总谐波极值发生时间 The occurrence time of the total harmonic extreme value of phase C voltage	R	3	Uint16	年, 月, 日, 时, 分, 秒 Year, Month, Day, Hour, M minute, Second
0xA0	THDIaP	A 相电流总谐波含有率 Total harmonic content rate of phase A current	R	2	Uint16	0.1%
0xA2	THDIaPTime	A 相电流总谐波极值发生时间 The occurrence time of the total harmonic extreme value of phase A current	R	3	Uint16	年, 月, 日, 时, 分, 秒 Year, Month, Day, Hour, M minute, Second
0xA5	THDIbP	B 相电流总谐波含有率 Total harmonic content rate of phase B current	R	2	Uint16	0.1%
0xA7	THDIbPTime	B 相电流总谐波极值发生时间 The occurrence time of the total harmonic extreme value of phase B current	R	3	Uint16	年, 月, 日, 时, 分, 秒 Year, Month, Day, Hour, M minute, Second
0xAA	THDIcP	C 相电流总谐波含有率 Total harmonic content rate of phase C current	R	2	Uint16	0.1%
0xAC	THDIcPTime	C 相电流总谐波极值发生时间 The occurrence time of the total harmonic extreme value of phase C	R	3	Uint16	年, 月, 日, 时, 分, 秒 Year, Month, Day, Hour, M minute, Second

		current				
--	--	---------	--	--	--	--

仪表谐波基波信息区 (功能码 03H、04H)

Instrument harmonic fundamental wave information area (Function codes 03H, 04H)

地址 Address	名称 Name	解释 Explanation	R/W	字长 Word	类型 Type	备注 Note
0x9B00	THDUaP	A 相电压总谐波含有率 Total harmonic content rate of phase A voltage	R	1	Uint16	0.01%
0x9B01	THDUbP	B 相电压总谐波含有率 Total harmonic content rate of phase B voltage	R	1	Uint16	0.01%
0x9B02	THDUcP	C 相电压总谐波含有率 Total harmonic content rate of phase C voltage	R	1	Uint16	0.01%
0x9B03	THDIaP	A 相电流总谐波含有率 Total harmonic content rate of phase A current	R	1	Uint16	0.01%
0x9B04	THDIbP	B 相电流总谐波含有率 Total harmonic content rate of phase B current	R	1	Uint16	0.01%
0x9B05	THDIcP	C 相电流总谐波含有率 Total harmonic content rate of phase C current	R	1	Uint16	0.01%
0x9B06	THDUaPO	A 相电压总奇次谐波含有率 The total odd harmonic content of phase A voltage	R	1	Uint16	0.01%
0x9B07	THDUbPO	B 相电压总奇次谐波含有率 The total odd harmonic content of phase B voltage	R	1	Uint16	0.01%
0x9B08	THDUcPO	C 相电压总奇次谐波含有率 The total odd harmonic content of phase C voltage	R	1	Uint16	0.01%
0x9B09	THDIaPO	A 相电流总奇次谐波含有率 The total odd harmonic content rate of phase A current	R	1	Uint16	0.01%
0x9B0A	THDIbPO	B 相电流总奇次谐波含有率 The total odd harmonic content rate of phase B	R	1	Uint16	0.01%

		current				
0x9B0B	THDIcPO	C 相电流总奇次谐波含有率 The total odd harmonic content rate of phase C current	R	1	Uint16	0.01%
0x9B0C	THDUaPE	A 相电压总偶次谐波含有率 The total even harmonic content of phase A voltage	R	1	Uint16	0.01%
0x9B0D	THDUbPE	B 相电压总偶次谐波含有率 The total even harmonic content of phase B voltage	R	1	Uint16	0.01%
0x9B0E	THDUcPE	C 相电压总偶次谐波含有率 The total even harmonic content of phase C voltage	R	1	Uint16	0.01%
0x9B0F	THDIaPE	A 相电流总偶次谐波含有率 The total even harmonic content rate of phase A current	R	1	Uint16	0.01%
0x9B10	THDIbPE	B 相电流总偶次谐波含有率 The total even harmonic content rate of phase B current	R	1	Uint16	0.01%
0x9B11	THDIcPE	C 相电流总偶次谐波含有率 The total even harmonic content rate of phase C current	R	1	Uint16	0.01%
0x9B12	THUaP (2-63)	A 相电压 2-63 次谐波含有率 The content rate of 2nd to 63rd harmonics in phase A voltage	R	1	Uint16	0.01%
0x9B50	THUbP (2-63)	B 相电压 2-63 次谐波含有率 The content rate of 2nd to 63rd harmonics in phase B voltage	R	1	Uint16	0.01%
0x9B8E	THUcP (2-63)	C 相电压 2-63 次谐波含有率 The content rate of 2nd to 63rd harmonics in phase C voltage	R	1	Uint16	0.01%

0x9BCC	THIaP (2-63)	A 相电流 2-63 次谐波含有率 The content rate of 2nd to 63rd harmonics in phase A current	R	1	Uint16	0.01%
0x9C0A	THIbP (2-63)	B 相电流 2-63 次谐波含有率 The content rate of 2nd to 63rd harmonics in phase B current	R	1	Uint16	0.01%
0x9C48	THIcP (2-63)	C 相电流 2-63 次谐波含有率 The content rate of 2nd to 63rd harmonics in phase C current	R	1	Uint16	0.01%

仪表报警记录信息区 (功能码 03H、04H)

Instrument alarm record information area (Function codes 03H, 04H)

报警记录共可读取 128 条。

地址 Address	名称 Name	解释 Explanation	R/W	字长 Word	类型 Type	备注 Note
0xA000	报警 1 记录 Alarm 1 Record	表示报警类型 高字节: 报警编号 1-90, High byte: Alarm number 1-90, 低字节: 0 表示报警解除, Low byte: 0: Alarm dismissed, 1 表示高报警, 2 表示低报警 1: high alarm, 2: low alarm	R	1	Uint16	地址 0xA000 Address 0xA000
0xA001	报警 1 年月 The year and month of Alarm 1	高字节: 年 High Byte: Year 低字节: 月 Low Byte: Month	R	1	Uint16	偏移 0x0001 Offset 0x0001
0xA002	报警 1 日时 The day and hour of Alarm 1	高字节: 年 High Byte: Year 低字节: 月 Low Byte: Month	R	1	Uint16	同上 Same as above
0xA003	报警 1 分秒 The minutes and seconds of alarm 1	高字节: 年 High Byte: Year 低字节: 月 Low Byte: Month	R	1	Uint16	同上 Same as above

0xA004	报警 1 毫秒 The seconds of alarm 1	毫秒 0-999ms 0-999ms in milliseconds	R	1	Uint16	同上 Same as above
0xA005	报警 1 值	报警产生时的值 The value when the alarm occurs	R	2	float	同上 Same as above
0xA007	报警 1 通道	表示报警 1 通道 低字节 Low byte: 1:表示报警 1 Alarm 1 2:表示报警 2 Alarm 2	R	1	Uint16	
0xA008	报警 2 记录	同报警 1 记录 Record the same as Alarm 1	R	8	Uint16	报警 2 记录首地址 Alarm 2 records the first address
.....	R	8	Uint16
0xA3F8	报警 128 记录	同报警 1 记录 Record the same as Alarm 1	R	8	Uint16	报警 128 记录首地址 Alarm 128 records the first address

报警编号 Alarm number

1: A 相电流 A phase current	2: B 相电流 B phase current	3: C 相电流 C phase current	4: 任意相电流 Arbitrary phase current	5: N 相电流 N phase current
6: A 相电压 A phase voltage	7: B 相电压 B phase voltage	8: C 相电压 C phase voltage	9: 任意相电压 Arbitrary phase voltage	10: AB 线电压 AB line voltage
11: BC 线电压 BC line voltage	12: CA 线电压 CA line voltage	13: 任意线电压 Arbitrary line voltage	14: A 相有功功 A phase active power	15: B 相有功功 B phase active power
16: C 相有功功	17: 总有功功	18: A 相无功	19: B 相无功	20: C 相无功

C phase active power	Total active power	A phase reactive power	B phase reactive power	C phase reactive power
21: 总无功 Total reactive power	22: A相视在 A phase apparent power	23: B相视在 B phase apparent power	24: C相视在 B phase apparent power	25: 总视在 Total apparent power
26: A相功率因数 A phase power factor	27: B相功率因数 B phase power factor	28: C相功率因数 C phase power factor	29: 总功率因数 Total power factor	30: 频率 Frequency
31: 电压不平衡度 Voltage imbalance	32: 电流不平衡度 Current imbalance	33: A相电流总谐波含有率 THD of Phase A current	34: B相电流总谐波含有率 THD of Phase B current	35: C相电流总谐波含有率 THD of Phase C current
36: A相电压总谐波含有率 THD of Phase A voltage	37: B相电压总谐波含有率 THD of Phase B voltage	38: C相电压总谐波含有率 THD of Phase C voltage	39: A相电流总偶次谐波含有率 Total even harmonic distortion (TEHD) of Phase A current	40: B相电流总偶次谐波含有率 Total even harmonic distortion (TEHD) of Phase B current
41: C相电流总偶次谐波含有率 Total even harmonic distortion (TEHD) of Phase C current	42: A相电压总偶次谐波含有率 Total even harmonic distortion (TEHD) of Phase A voltage	43: B相电压总偶次谐波含有率 Total even harmonic distortion (TEHD) of Phase B voltage	44: C相电压总偶次谐波含有率 Total even harmonic distortion (TEHD) of Phase C voltage	45: A相电流总奇次谐波含有率 Total odd harmonic distortion (TOHD) of Phase A current
46: B相电流总奇次谐波含有率 Total odd harmonic distortion (TOHD) of Phase B current	47: C相电流总奇次谐波含有率 Total odd harmonic distortion (TOHD) of Phase C current	48: A相电压总奇次谐波含有率 Total odd harmonic distortion (TOHD) of Phase A voltage	49: B相电压总奇次谐波含有率 Total odd harmonic distortion (TOHD) of Phase B voltage	50: C相电压总奇次谐波含有率 Total odd harmonic distortion (TOHD) of Phase C voltage
51: A相电流需量报警 A phase current demand alarm	52: B相电流需量报警 B phase current demand alarm	53: C相电流需量报警 C phase current demand alarm	54: 总正向有功需量报警 Total forward active demand alarm	55: 总反向有功需量报警 Total reverse active demand alarm

56: 总正向无功需量报警 Total forward reactive power demand alarm	57: 总反向无功需量报警 Total reverse reactive power demand alarm	58: 总视在功率需量报警 T Total apparent power demand alarm	59: DI1 报警 DI1 alarm	60: DI2 报警 DI2 alarm
61: DI3 报警 DI3 alarm	62: DI4 报警 DI4 alarm	63: DI5 报警 DI5 alarm	64: DI6 报警 DI6 alarm	65: DI7 报警 DI7 alarm
66: DI8 报警 DI8 alarm	67: DI9 报警 DI9 alarm	68: DI10 报警 DI10 alarm	69: DI11 报警 DI11 alarm	70: DI12 报警 DI12 alarm
71: DI13 报警 DI13 alarm	72: DI14 报警 DI14 alarm	73: DI15 报警 DI15 alarm	74: DI16 报警 DI16 alarm	

仪表事件记录信息区（功能码 03H 、 04H）

Instrument event record information area (Function codes 03H, 04H)

事件记录共可读取 128 条。

地址 Address	名称 Name	解释 Explanation	R/W	字长 Word	类型 Type	备注 Note
0xA400	事件 1 记录 Event 1 Record	高字节: 0 表示无 1 表示 DO 2 表示 DI High byte 0: None 1: DO 2: DI 低字节: 0 表示断开 1 表示闭合 Low byte 0: Fracture 1: Closed	R	1	Uint16	0xA400
0xA401	动作通道 Action channel	动作通道 1~8 Channels 1 to 8	R	1	Uint16	偏移 0x0001 Offset 0x0001
0xA402	动作年月 Action year and month	高字节: 年 High Byte: Year 低字节: 月 Low Byte: Month	R	1	Uint16	同上 Same as above
0xA403	动作日时 Action day and hours	高字节: 日 High Byte: Day 低字节: 时 Low Byte: Hours	R	1	Uint16	同上 Same as above
0xA404	动作分秒	高字节: 分 High byte: minutes	R	1	Uint16	同上

	Action minute and second	低字节：秒 Low byte: seconds				Same as above
0xA405	动作毫秒 Action milliseconds	毫秒 0-999ms 0-999ms in milliseconds	R	1	Uint32	同上 Same as above
0xA406	事件 2 记录 Event 2 record	同事件 1 记录 Record the same as Event 1	R	6	Uint16	事件 2 记录首地址 Event 2 records the first address
.....	R	6	Uint16	...
0xA6F8	事件 128 记录 Event 128 record	同事件 1 记录 Record the same as Event 1	R	6	Uint16	事件 128 记录首地址 Event 128 records the first address

报警状态（功能码 03H 、04H）

Alarm status (Function codes 03H, 04H)

地址 Address	名称 Name	解释 Explanation	R/W	字长 Word	类型 Type	备注 Note
报警 1 状态 Alarm 1 status						
0xA800	报警 1 状态 Alarm 1 status	0-15 报警 0: 否 1: 报警 0-15 Alarm 0: No 1: Alarm	R	1	Uint16	
0xA801	报警 1 状态 Alarm 1 status	16-31 报警 0: 否 1: 报警 16-31 Alarm 0: No 1: Alarm	R	1	Uint16	
0xA802	报警 1 状态 Alarm 1 status	32-47 报警 0: 否 1: 报警 32-47 Alarm 0: No 1: Alarm	R	1	Uint16	
0xA803	报警 1 状态 Alarm 1 status	48-63 报警 0: 否 1: 报警 48-63 Alarm 0: No 1: Alarm	R	1	Uint16	

0xA804	报警 1 状态 Alarm 1 status	64-79 报警 0: 否 1: 报警 64-79 Alarm 0: No 1: Alarm	R	1	Uint16	
0xA805	报警 1 状态 Alarm 1 status	80-95 报警 0: 否 1: 报警 80-95 Alarm 0: No 1: Alarm	R	1	Uint16	
报警 2 状态 Alarm 2 status						
0xA820	报警 2 状态 Alarm 2 status	0-15 报警 0: 否 1: 报警 0-15 Alarm 0: No 1: Alarm	R	1	Uint16	
0xA821	报警 2 状态 Alarm 2 status	16-31 报警 0: 否 1: 报警 16-31 Alarm 0: No 1: Alarm	R	1	Uint16	
0xA822	报警 2 状态 Alarm 2 status	32-47 报警 0: 否 1: 报警 32-47 Alarm 0: No 1: Alarm	R	1	Uint16	
0xA823	报警 2 状态 Alarm 2 status	48-63 报警 0: 否 1: 报警 48-63 Alarm 0: No 1: Alarm	R	1	Uint16	
0xA824	报警 2 状态 Alarm 2 status	64-79 报警 0: 否 1: 报警 64-79 Alarm 0: No 1: Alarm	R	1	Uint16	
0xA825	报警 2 状态 Alarm 2 status	80-95 报警 0: 否 1: 报警 80-95 Alarm 0: No 1: Alarm	R	1	Uint16	
0xB015	UA 电压偏差 UA voltage deviation		R	1	Int16	
0xB016	UB 电压偏差 UB voltage deviation		R	1	Int16	
0xB017	UC 电压偏差 UC voltage deviation		R	1	Int16	
0xB018	UAB 电压偏差		R	1	Int16	

	UAB voltage deviation					
0xB019	UBC 电压偏差 UBC voltage deviation		R	1	Int16	
0xB01A	UCA 电压偏差 UCA voltage deviation		R	1	Int16	
0xB01B	IA 电流偏差 IA current deviation		R	1	Int16	
0xB01C	IB 电流偏差 IB current deviation		R	1	Int16	
0xB01D	IC 电流偏差 IC current deviation		R	1	Int16	
0xB01E	频率偏差 Frequency deviation		R	1	Int16	
上一次冻结数据 Last frozen data						
0xC400	正向有功电能 Positive active electric energy		R	2	float	
0xC402	反向有功电能 Reverse active electric energy		R	2	float	
0xC404	感性无功电能		R	2	float	

	Inductive reactive electric energy					
0xC406	容性无功电能 Capacitive reactive electric energy		R	2	float	
0xC408	A 相电流需量 Phase A current demand		R	2	float	
0xC40A	B 相电流需量 Phase B current demand		R	2	float	
0xC40C	C 相电流需量 Phase C current demand		R	2	float	
0xC40E	有功功率需量 active power demand		R	2	float	
0xC410	无功功率需量 Reactive power demand		R	2	float	
0xC412	视在功率需量 Apparent power demand		R	2	float	
0xC414	A 相电流 Phase A current		R	2	float	
0xC416	B 相电流 Phase B current		R	2	float	

0xC418	C 相电流 Phase C current		R	2	float	
0xC41A	UAB		R	2	float	
0xC41C	UBC		R	2	float	
0xC41E	UCA		R	2	float	
0xC420	有功功率 active power		R	2	float	
0xC422	无功功率 Reactive power		R	2	float	
0xC424	视在功率 Apparent power		R	2	float	
0xC426	功率因数 Power factor		R	2	float	
0xC428	年月 Year、Month		R	2	Uint16	
0xC429	日时 Day、Hour		R	2	Uint16	
0xC42A	分秒 Minute、Second		R	2	Uint16	
0xC42B	预留 Retain		R	2	Uint16	
0XC5E4 -0XC60F	上 N 次冻结数据 Last N frozen data					

序列号传输点表 Serial number transmission point table:

地址 Address	名称 Name	解释 Explanation	R/W	字长 Word	类型 Type	备注 Note
---------------	------------	-------------------	-----	------------	------------	------------

0xf000~0xf006	Serialnum	序列号 Serial number	R	14	Char	
0xf007	softcode	软件编号 Software Number	R	1	Uint16	
0xf008	Softversion	软件版本号 Software version number	R	1	Uint16	
0xf009~0xf010	Meter_type	仪表型号 Meter model	R	16	Char	
0xf011	otime	注册重置时间 Registration reset time	R/W	1	Uint16	min

相序调整

地址 Address	名称 Name	字长 Word	类型 Type	R/W	备注 Note
9000	相序开启使能(AdjustEN) Phase sequence opening enable	2	Uint16	R/W	
9001	相序校正方案(AdjustMethod) Phase sequence correction scheme	2	Uint16	R/W	
9002	互感器极性调整, bit0:A相, bit1:B相, bit2:C相 (AdjustCurrent) Transformer polarity adjustment, bit0: Phase A, bit1: Phase B, bit2: Phase C	2	Uint16	R/W	
9003	相角判断阈值, 单位 0.01° (AdjustAngleValue) Phase Angle judgment threshold, unit 0.01°	2	Uint16	R/W	
9004	功率因数判断阈值(AdjustPfValue) Power factor judgment threshold	2	Uint16	R/W	
9005	电流断线检测使能(LoopCheckEN) Current break detection enabled	2	Uint16	R/W	
9006	电流断线检测阈值, 单位 0.01A(LoopCheckValue)	2	Uint16	R/W	

	Current break detection threshold, unit 0.01A				
9007	电流断线检测周期, 单位分钟 (LoopCheckTime) Current break detection period, in minutes	2	Uint16	R/W	
9008	自动校准相位, 不存铁电, 执行完一次自动复位 (AutoAdjustAngleEN) Automatic phase calibration, no ferroelectric storage, automatic reset is performed	2	Uint16	R/W	
9009	互感器断线状态, bit0:A相, bit1:B相, bit2:C相 (LoopState) The transformer is broken, bit0: phase A, bit1: phase B, bit2: phase C	2	Uint16	R	
900A	Angle_ua	2	Uint16	R	
900B	Angle_ub	2	Uint16	R	
900C	Angle_uc	2	Uint16	R	
900D	Angle_ia	2	Uint16	R	
900E	Angle_ib	2	Uint16	R	
900F	Angle_ic	2	Uint16	R	
9010	接线自查方案数量 Number of wiring self-check schemes	2	Uint16	R	
9011	相序调节 1 方案 Phase sequence adjustment 1 scheme	2	Uint16	R	
9012	电流方向 Direction of current	2	Uint16	R	
9013	调节后平均相角 1 Average phase Angle after adjustment 1	2	Uint16	R	
9014	相序调节 2 方案 Phase sequence adjustment 2 scheme	2	Uint16	R	
9015	电流方向	2	Uint16	R	

	Direction of current				
9016	调节后平均相角 2 Average phase Angle after adjustment 2	2	Uint16	R	
9017	相序调节 3 方案 Phase sequence adjustment 3 scheme	2	Uint16	R	
9018	电流方向 Phase sequence adjustment 3 scheme	2	Uint16	R	
9019	调节后平均相角 3 Average phase Angle after adjustment3	2	Uint16	R	
901A	相序调节 4 方案 Phase sequence adjustment 4 scheme	2	Uint16	R	
901B	电流方向 Direction of current	2	Uint16	R	
901C	调节后平均相角 4 Average phase Angle after adjustment 4	2	Uint16	R	
901D	相序调节 5 方案 Phase sequence adjustment 5 scheme	2	Uint16	R	
901E	电流方向 Direction of current	2	Uint16	R	
901F	调节后平均相角 5 Average phase Angle after adjustment 5	2	Uint16	R	
9020	相序调节 6 方案 Phase sequence adjustment 6 scheme	2	Uint16	R	
9021	电流方向 Direction of current	2	Uint16	R	
9022	调节后平均相角 6 Average phase Angle after adjustment 6	2	Uint16	R	
9023	相序调节 7 方案	2	Uint16	R	

	Phase sequence adjustment 7 scheme				
9024	电流方向 Direction of current	2	Uint16	R	
9025	调节后平均相角 7 Average phase Angle after adjustment 7	2	Uint16	R	
9026	相序调节 8 方案 Phase sequence adjustment 8 scheme	2	Uint16	R	
9027	电流方向 Direction of current	2	Uint16	R	
9028	调节后平均相角 8 Average phase Angle after adjustment 8	2	Uint16	R	
9029	相序调节 9 方案 Phase sequence adjustment 9 scheme	2	Uint16	R	
902A	电流方向 Direction of current	2	Uint16	R	
902B	调节后平均相角 9 Average phase Angle after adjustment 9	2	Uint16	R	
902C	相序调节 10 方案 Phase sequence adjustment 10 scheme	2	Uint16	R	
902D	电流方向 Direction of current	2	Uint16	R	
902E	调节后平均相角 10 Average phase Angle after adjustment 10	2	Uint16	R	
902F	相序调节 11 方案 Phase sequence adjustment 11 scheme	2	Uint16	R	
9030	电流方向 Direction of current	2	Uint16	R	
9031	调节后平均相角 11	2	Uint16	R	

	Average phase Angle after adjustment 11				
9032	相序调节 12 方案 Phase sequence adjustment 12 scheme	2	Uint16	R	
9033	电流方向 Direction of current	2	Uint16	R	
9034	调节后平均相角 12 Average phase Angle after adjustment 12	2	Uint16	R	
9035	tmpmethod_i	2	Uint16	R	
9036	DealAdjustCurrent	2	Uint16	R	

仪表运行时间

地址 Address	名称 Name	字长 Word	类型 Type	R/W	备注 Note
10A1	运行时间 Run Time	4	Uint32	R	秒 s
10A3	带载时间 Load Time	4	Uint32	R	秒 s
10A5	空载时间 No-load Time	4	Uint32	R	秒 s
10A7	带载电流 Load Current	4	Uint16	R/W	

选配 E 功能时，SD 卡读取内容：

When the E - function is optionally selected, the content read from the SD card:

查看 MicroSD 数据记录：MicroSD 卡中包含的数据记录文件有基本电参量的数据，数据以日期命名（如 23 号命名为“23”），存放在相应的按“年月”（例如 2000-01）命名的文件夹下。

Viewing MicroSD Data Records: The data record files contained in the MicroSD card include basic electrical parameter data. The data is named by date (e.g., the 23rd is named "23") and stored in the corresponding folder named by "year-month" (e.g., 2000-01).

注：第一插入的 SD 卡需要上位机对其按 FAT32 格式化。

Note: The first SD card inserted needs to be formatted to FAT32 by the host computer.

APM521 支持上位机查看 SD 卡数据，通过以太网连接到子模块，使用“FileZilla Client”软件：主机地址即“通讯设置”里的“IP 地址”，用户名：APM，密码：12345678(默认)。点击快速连接即可连接到子模块。

APM521 supports the host computer to view SD card data. Connect to the sub-module via Ethernet and use the "FileZilla Client" software: the host address is the "IP address" in "Communication Settings", username: APM, password: 12345678 (default). Click Quickconnect to connect to the sub-module.

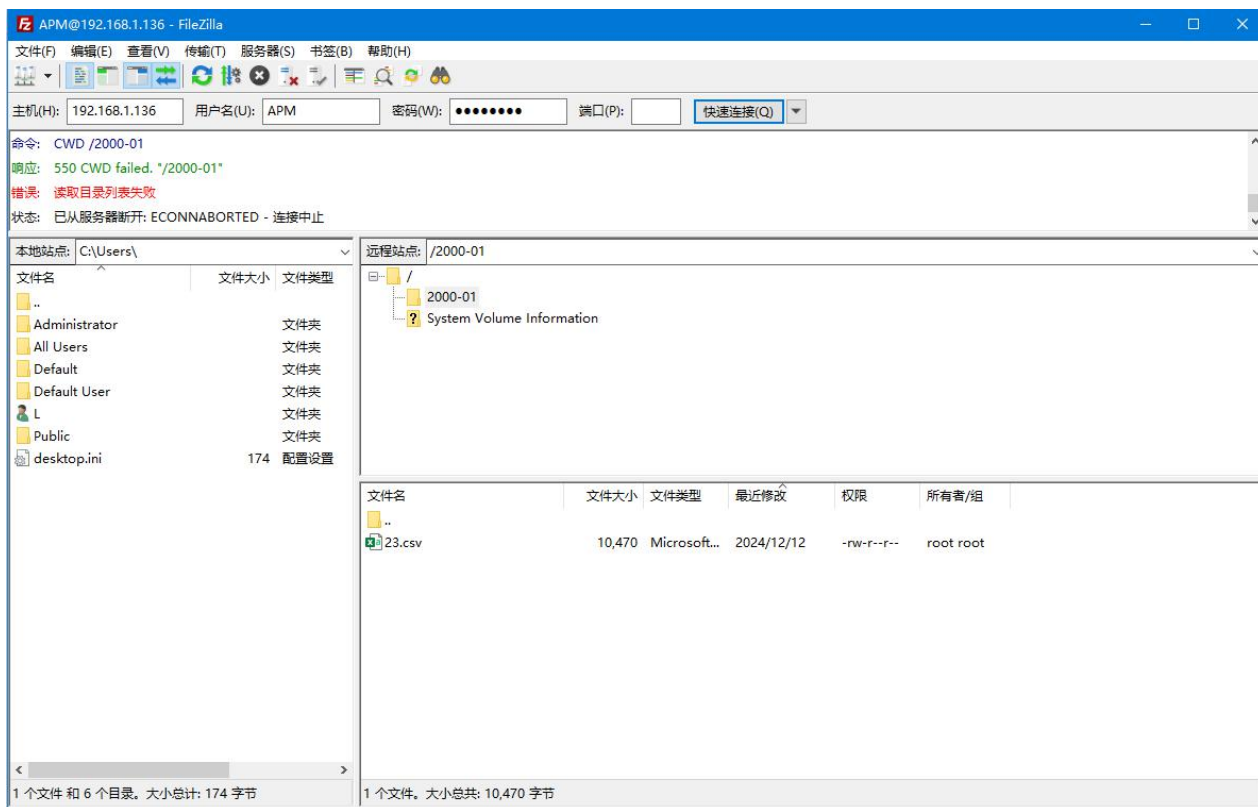

双击以”年份_月份”命名的文件夹(如:2000-01),子文件夹下包含以”日期”命名的.csv 记录文件(如: 23.csv), 可将文件下载到本地, 当显示”文件传输成功”, 即可查看报警数据。记录文件包含: 日期; 时间; 基本电参量

Double-click the folder named in the "Year-Month" format (e.g., 2000-01). This subfolder contains .csv log files named after dates (e.g., 23.csv). You can download these files to your local device, and once "File transfer successful" is displayed, you can view the alarm data. Each log file includes the following information: Date; Time; Basic electrical parameters

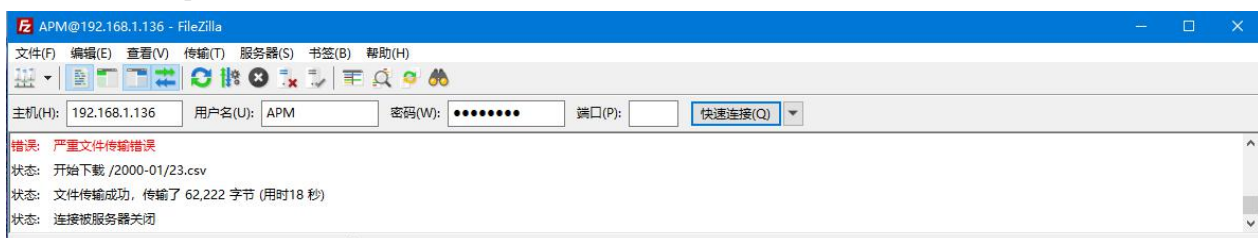

注: 仪表默认 1 分钟记录 1 次电参量数据(一次侧),时间间隔可设,时间间隔单位:minute。

Note: The instrument records electrical parameter data (primary side) once per minute by default. The time interval is configurable, with the unit of time interval being "minute".

符号	含义	单位
Time	该次电参量记录时间 The recording time of the electrical parameter data for this instance	年/月/日 时: 分 Year/Month/Day Hour:Minute
Ua	A 相电压 A phase voltage	0.1V
Ub	B 相电压 B-phase voltage	0.1V
Uc	C 相电压 C-phase voltage	0.1V

Uab	AB 线电压 AB line voltage	0.1V
Ubc	BC 线电压 BC line voltage	0.1V
Uca	CA 线电压 CA line voltage	0.1V
Ia	A 相电流 A phase current	0.001A
Ib	B 相电流 B phase current	0.001A
Ic	C 相电流 C phase current	0.001A
Pa	A 相有功功率 A phase active power	0.001W
Pb	B 相有功功率 B phase active power	0.001W
Pc	C 相有功功率 C phase active power	0.001W
P	总有功功率 Total active power	0.001W
Qa	A 相无功功率 A phase reactive power	0.001W
Qb	B 相无功功率 B-phase reactive power	0.001W
Qc	C 相无功功率 C-phase reactive power	0.001W
Q	总无功功率 Total reactive power	0.001W
Sa	A 相视在功率 A-phase apparent power	0.001W
Sb	B 相视在功率 B-phase apparent power	0.001W
Sc	C 相视在功率 C-phase apparent power	0.001W
S	总视在功率 Total apparent power	0.001W
PFa	A 相功率因数 A phase power factor	0.001
PFb	B 相功率因数 B-phase power factor	0.001
PFc	C 相功率因数 C-phase power factor	0.001
Fr	总功率因数 Total power factor	0.001

注: Micro SD 卡(TF 卡)中的数据均为只读,文件记录数据均为 excel,请用 Microsoft Office Excel07 版本及 07 版本以上打开,用低于 Microsoft Office Excel07 版本或 WPS 打开会有部分数据丢失。

Note: All data in the Micro SD card (TF card) is read-only, and the file-recorded data is in Excel format. Please open these files using Microsoft Office Excel 2007 or later versions. Opening them with Microsoft Office Excel versions earlier than 2007 or with WPS may result in partial data loss.

总部：安科瑞电气股份有限公司

地址：上海市嘉定区育绿路 253 号

电话：0086-021-69158161

网址：www.acrel.cn

邮箱：acrelsh@email.acrel.cn

邮编：201801

生产基地：江苏安科瑞电器制造有限公司

地址：江苏省江阴市南闸街道东盟工业园区东盟路 5 号

电话：0086-510-86179966

网址：www.jsacrel.cn

邮箱：jyacrel001@email.acrel.cn

邮编：214405

Headquarters: Acrel Co., Ltd.

Trade Company: Acrel E-Business(Shanghai)Co., Ltd.

Address: No.253 Yulv Road, Jiading District, Shanghai, China

TEL.: 0086-21-69156352

Web-site: www.acrel-electric.com

E-mail: sales@acrel-electric.com

Postcode: 201801

Manufacturer: Jiangsu Acrel Electrical Manufacturing Co., Ltd.

Address: No.5 Dongmeng Road, Dongmeng industrial Park, Nanzha Street, Jiangyin City, Jiangsu Province,
China

TEL./Fax: 0086-510-86179970

Web-site: www.jsacrel.com

E-mail: sales@email.acrel.cn

Postcode: 214405